

Ultra Precision Resistors

Databook

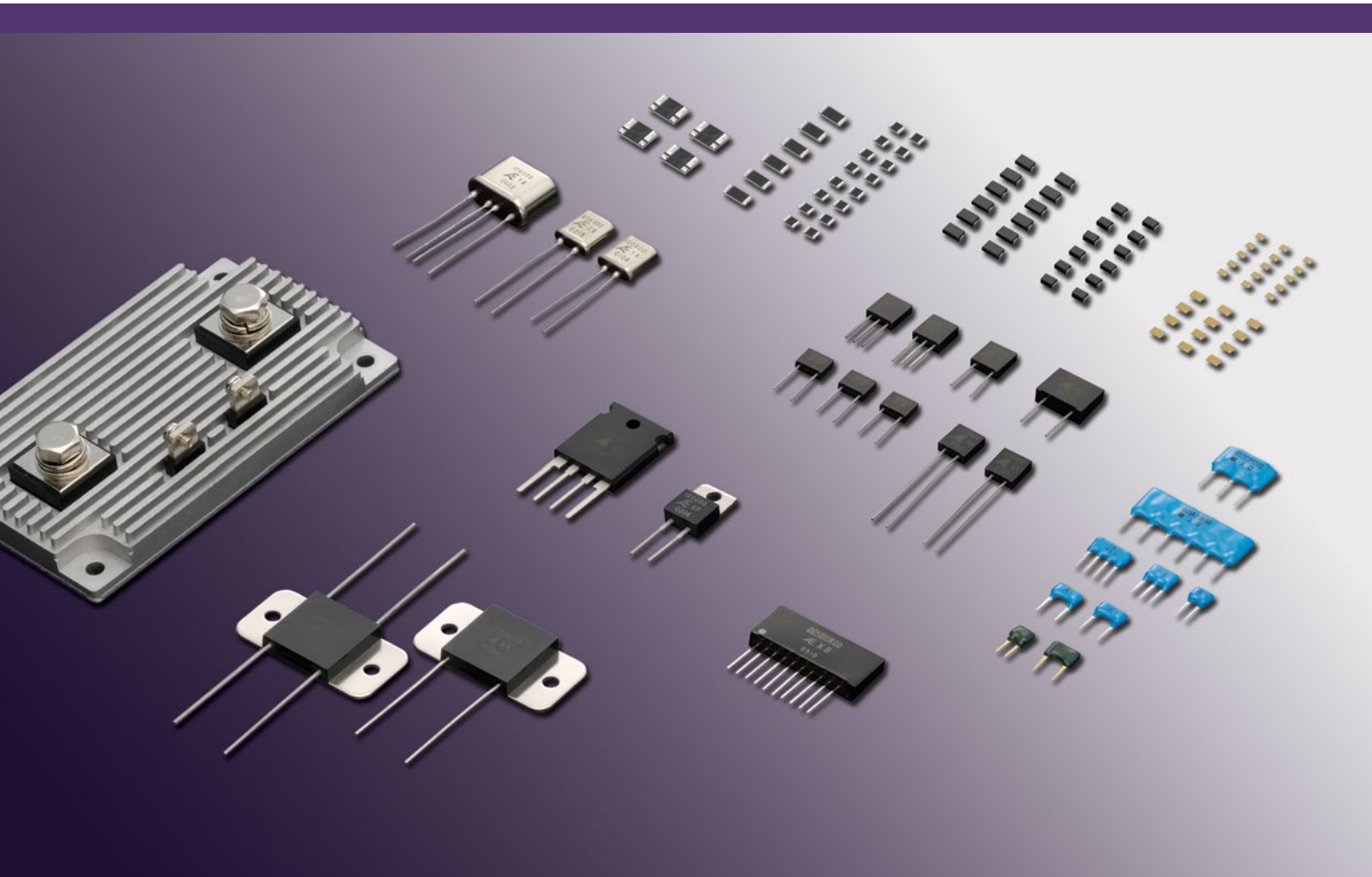

Bulk Metal® Foil
Thin Film
Thermosensitive

Ultra Precision Resistors

Disclaimer

ALL PRODUCTS, PRODUCT SPECIFICATIONS AND DATA ARE SUBJECT TO CHANGE WITHOUT NOTICE.

Vishay Precision Group, Inc., its affiliates, agents, and employees, and all persons acting on its or their behalf (collectively, "VPG"), disclaim any and all liability for any errors, inaccuracies or incompleteness contained herein or in any other disclosure relating to any product.

The product specifications do not expand or otherwise modify VPG's terms and conditions of purchase, including but not limited to, the warranty expressed therein.

VPG makes no warranty, representation or guarantee other than as set forth in the terms and conditions of purchase. **To the maximum extent permitted by applicable law, VPG disclaims (i) any and all liability arising out of the application or use of any product, (ii) any and all liability, including without limitation special, consequential or incidental damages, and (iii) any and all implied warranties, including warranties of fitness for particular purpose, non-infringement and merchantability.**

Information provided in datasheets and/or specifications may vary from actual results in different applications and performance may vary over time. Statements regarding the suitability of products for certain types of applications are based on VPG's knowledge of typical requirements that are often placed on VPG products. It is the customer's responsibility to validate that a particular product with the properties described in the product specification is suitable for use in a particular application. You should ensure you have the current version of the relevant information by contacting VPG prior to performing installation or use of the product, such as on our website at vpgsensors.com.

No license, express, implied, or otherwise, to any intellectual property rights is granted by this document, or by any conduct of VPG.

The products shown herein are not designed for use in life-saving or life-sustaining applications unless otherwise expressly indicated. Customers using or selling VPG products not expressly indicated for use in such applications do so entirely at their own risk and agree to fully indemnify VPG for any damages arising or resulting from such use or sale. Please contact authorized VPG personnel to obtain written terms and conditions regarding products designed for such applications.

Product names and markings noted herein may be trademarks of their respective owners.

Alphabetical Index.....	2
Bulk Metal® Foil Precision Resistor — Manufacturing Process, Adjustment of Resistance Value Construction, and Temperature Characteristics of Resistance	3
Metal Foil Resistors—Surface Mount	
RWA, RWB, RWC — Precision SMS Bulk Metal® Foil Resistor (Wraparound)	6
MPP, MQP Series — Z-Foil Ultra High-Precision SMT Resistor (Molded, J-Lead Terminal).....	8
MP, MQ Series — Ultra Precision SMT Resistor (Molded, J-Lead Terminal)	10
MU Series — Ultra Precision SMT Resistor 1-2-3 Network	12
RBD, RBF, RBH Series — Ultra Precision SMT Current Sense Resistor (Flip-Chip)	14
Metal Foil Resistors—Through-Hole	
MA, MB, MC, MD Series — Ultra Precision Resistor (Transfer Molded)	16
FLA, FLB, FLC Series — Precision Resistor (Conformally Coated)	18
SLD, SM Series — Ultra Precision Resistor 1-2-3 Network	20
FNP Series — High Power Precision Shunt Resistor, Up to 500W	22
PSB Series — Ultra Precision Shunt Resistor (40 Watts)	24
PB, PC Series — Ultra Precision Power Resistor (10 Watts)	26
PE Series — Ultra Precision Shunt Resistor (10 Watts, TO Package)	28
PD Series — Ultra Precision Power Resistor (8 Watts, TO-220)	30
HC, HD, HG Series — Ultra Precision Resistor (Hermetically Sealed)	32
HK, HL Series — Zero-TCR Ultra Precision Resistor (Hermetically Sealed)	34
Ultra Precision Resistor Network	36
SC Series — Ultra Precision Resistor Network (Case-Encapsulated)	37
SE, SF, SS Series — Precision Resistor Network (Conformally Coated)	38
Thin Film Resistors—Through-Hole	
TLA, TLC Series — Precision Thin Film Resistor (Conformally Coated)	39
Ultra Precision Thermosensitive Resistors—Surface Mount and Through-Hole	
CLA, CLB, KLC, NLA, NLB, NMP, NMQ Series — Ultra Precision Thermosensitive Resistor	40
Custom Products — Products for Ultra Precision Resistors and Temperature Sensors	43
Global Contact Map	44
About VPG Foil Resistors	45

About VPG Foil Resistors	45
Bulk Metal® Foil Precision Resistor — Manufacturing Process, Adjustment of Resistance Value Construction, and Temperature Characteristics of Resistance	3
CLA, CLB, KLC, NLA, NLB, NMP, NMQ Series — Ultra Precision Thermosensitive Resistor	40
Custom Products — Products for Ultra Precision Resistors and Temperature Sensors	43
FLA, FLB, FLC Series — Precision Resistor (Conformally Coated)	18
FNP Series — High Power Precision Shunt Resistor, Up to 500W	22
Global Contact Map	44
HC, HD, HG Series — Ultra Precision Resistor (Hermetically Sealed)	32
HK, HL Series — Zero-TCR Ultra Precision Resistor (Hermetically Sealed)	34
MPP, MQP Series — Z-Foil Ultra High-Precision SMT Resistor (Molded, J-Lead Terminal).....	8
MP, MQ Series — Ultra Precision SMT Resistor (Molded, J-Lead Terminal)	10
MU Series — Ultra Precision SMT Resistor 1-2-3 Network	12
MA, MB, MC, MD Series — Ultra Precision Resistor (Transfer Molded)	16
PSB Series — Ultra Precision Shunt Resistor (40 Watts)	24
PB, PC Series — Ultra Precision Power Resistor (10 Watts)	26
PE Series — Ultra Precision Shunt Resistor (10 Watts, TO Package)	28
PD Series — Ultra Precision Power Resistor (8 Watts, TO-220)	30
RWA, RWB, RWC — Precision SMS Bulk Metal® Foil Resistor (Wraparound)	6
RBD, RBF, RBH Series — Ultra Precision SMT Current Sense Resistor (Flip-Chip)	14
SLD, SM Series — Ultra Precision Resistor 1-2-3 Network	20
SC Series — Ultra Precision Resistor Network (Case-Encapsulated)	37
SE, SF, SS Series — Precision Resistor Network (Conformally Coated)	38
TLA, TLC Series — Precision Thin Film Resistor (Conformally Coated)	39
Ultra Precision Resistor Network	36

Manufacturing Process, Adjustment of Resistance Value Construction, and Temperature Characteristics of Resistance

A Bulk Metal® foil high precision resistor, unlike a precision-class metal film resistor or wire-wound resistor, is an ultra precision resistor in which the primary resistance element is a special alloy foil several μm thick.

Use of this Bulk Metal® Foil as the resistance element gives superior performance not found in other resistors, satisfying military specification MIL-PRF-55182/9. In particular, the temperature coefficient of resistance has been reduced to an unprecedented, extremely low value by strict quality control of alloy composition and newly developed foil stabilization treatment technology. In addition, from the point of view of long-term stability, which is an important property of a resistor since the foil has a thickness of several μm instead of the extremely thin film of a metal film resistor, the natural stability of metal is preserved, resulting in very little resistance change over several years.

By developing our own original fine photo-etching technology, we have made it possible to form the complicated resistance pattern required for highly accurate resistance values.

MAIN APPLICATIONS

Precise amplifier circuitry and referential power supply in items such, as sophisticated electronic equipment, instrumentation and medical electronic apparatus.

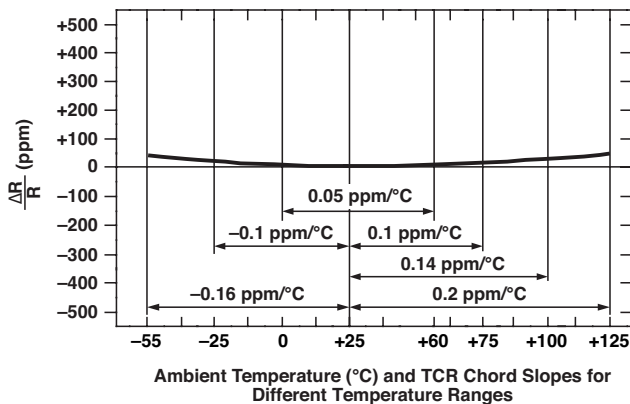
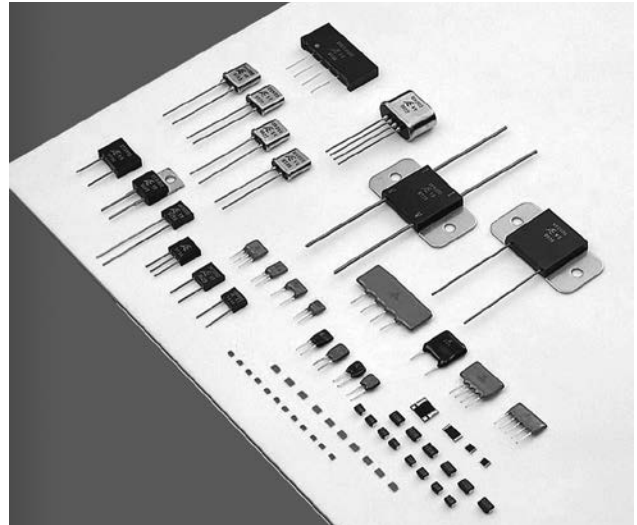

CHARACTERISTICS

- ❶ Temperature Coefficient of Resistance:
0.05 ppm/°C (Typical, 0°C to +60°C)
- ❷ Resistance Tolerance: $\pm 0.005\%$
- ❸ Shelf Life:
25 ppm/year; 50 ppm/3 years
(Hermetically sealed: 5 ppm/year
10 ppm/3 years)
- ❹ Load Life:
0.005%/2,000 hours at Rated Power (typical)
- ❺ Thermal EMF: 0.1 $\mu\text{V}/^\circ\text{C}$ (between leads)
- ❻ Noise: -42 dB
- ❼ Voltage Coefficient: 0.3 ppm/V
- ❽ Frequency Characteristics:
Inductance: 0.08 μH
Capacitance: 0.5 pF

Manufacturing Process, Adjustment of Resistance Value Construction, and Temperature Characteristics of Resistance

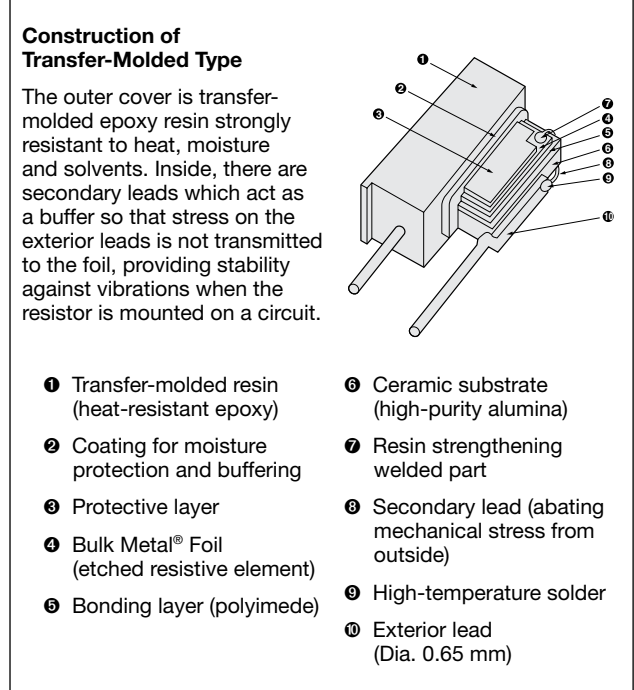
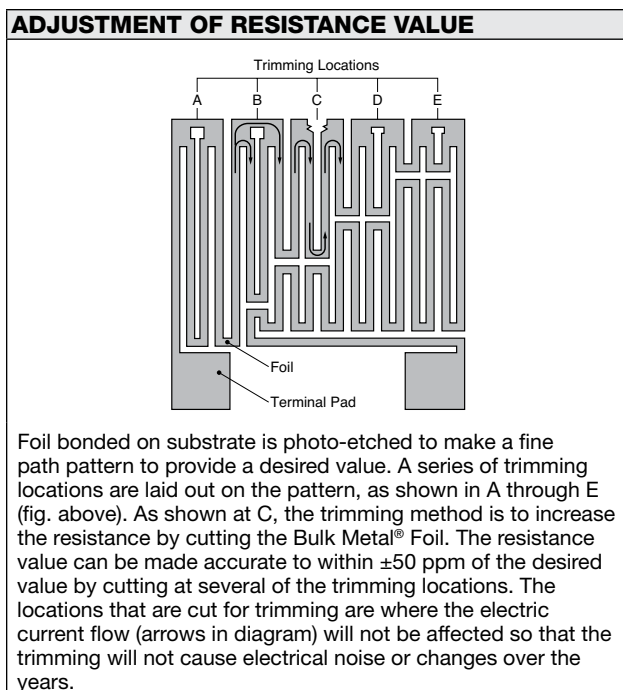
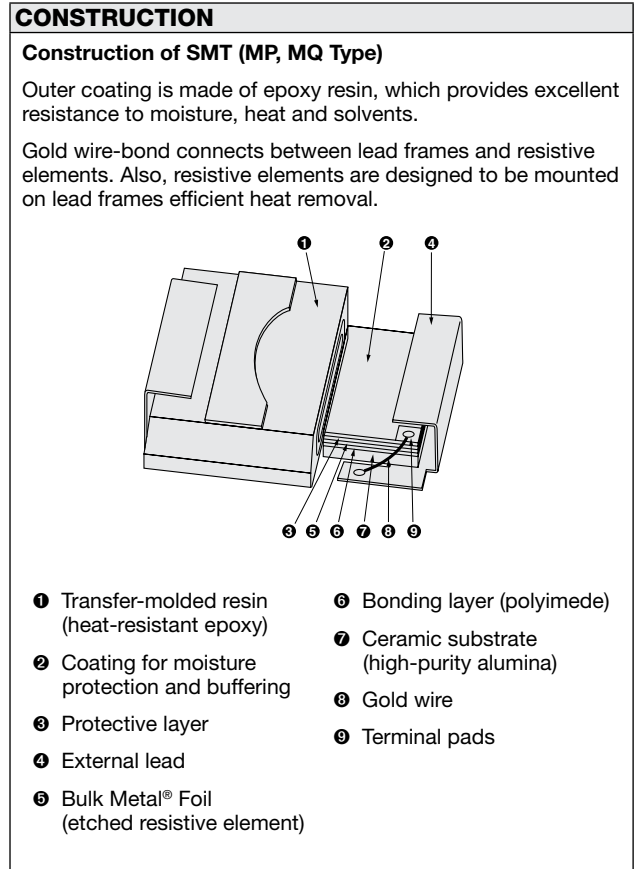
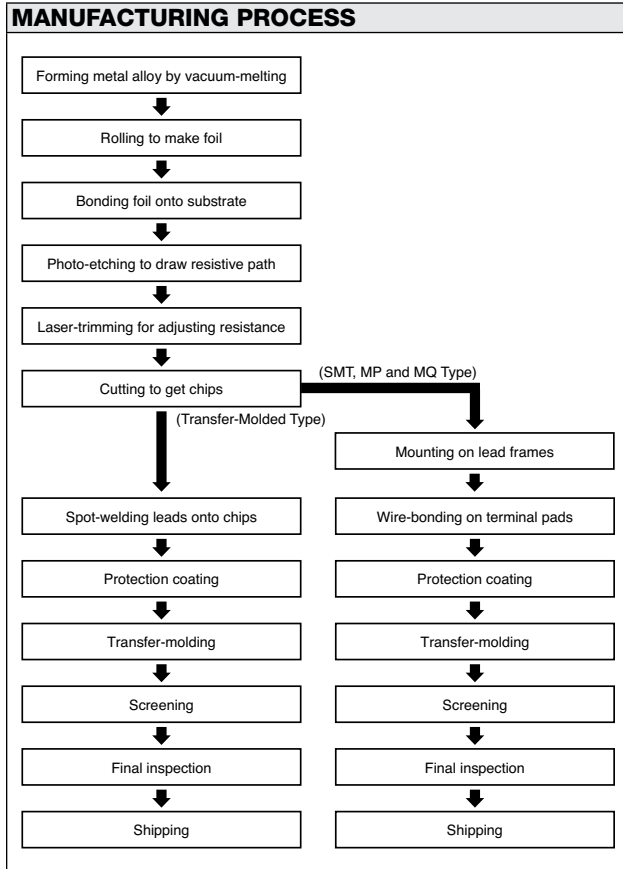

Manufacturing Process, Adjustment of Resistance Value Construction,
and Temperature Characteristics of Resistance

TEMPERATURE CHARACTERISTICS OF RESISTANCE

Char.S

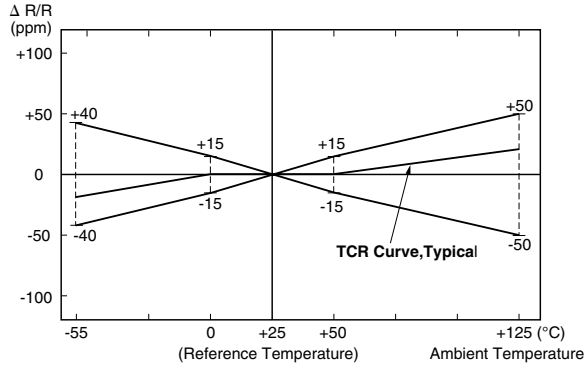

Temperature (°C)	$\Delta R/R$ (ppm)
-55	0 ± 40
0	0 ± 15
+50	0 ± 15
+125	0 ± 50

Reference Temperature +25°C

Char.Z (0 ± 1 ppm/°C)

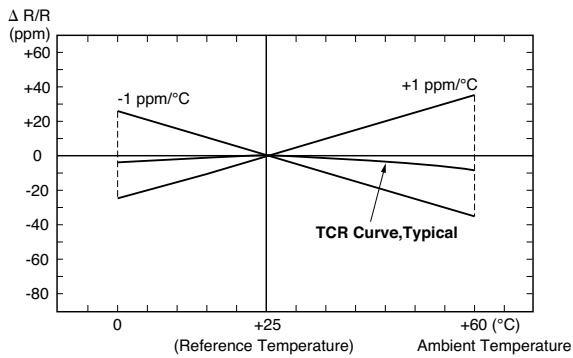

Char.Y (0 ± 2.5 ppm/°C)

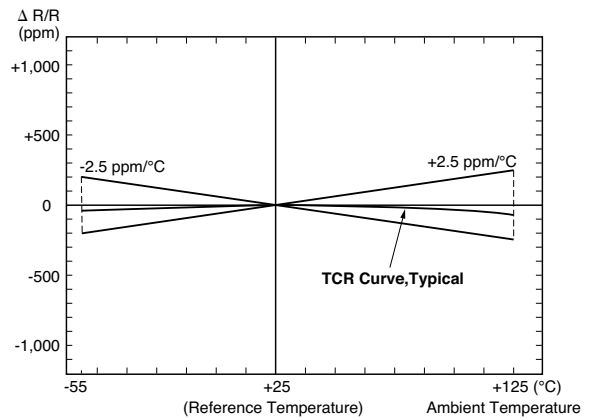

Char.X (0 ± 5 ppm/°C)

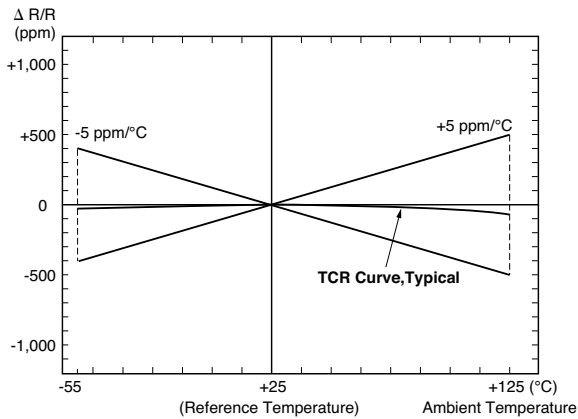

Char.W (0 ± 15 ppm/°C)

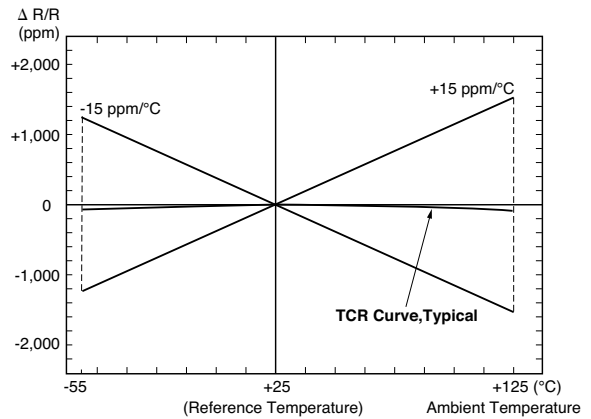

Precision SMD Bulk Metal® Foil Resistor (Wraparound)

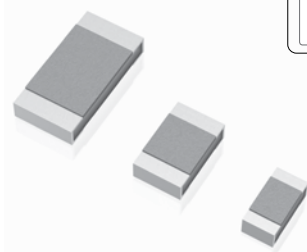

FEATURES

- High precision and stable Bulk Metal® Foil resistor with 0603, 0805 and 1206 package
- TCR: 0±2 ppm/°C, 0±5 ppm/°C
- Resistance tolerance: up to ±0.01%
- Load-life stability: ±0.005% (typical, 70°C, 2000 hrs., rated power)
- No standard resistance value (example: 1K234Ω)
- MOQ: 100 pieces

COMPOSITION OF TYPE NUMBER

Example:

RWC 10K00 Q L

— Tape and Reel Package
— Resistance Tolerance
— Resistance Value
— Type

Resistance value is expressed by 4 numbers and 1 alphabet. R or K is a dual-purpose letter that designates both the value range (R for ohmic, K for kilohm) and the location of decimal point.

CONFIGURATION — DIMENSIONS IN mm

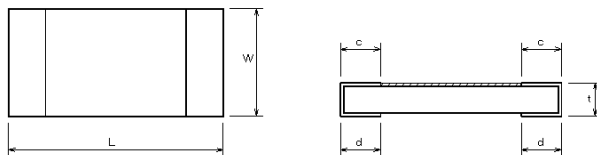

Type	RWA	RWB	RWC
L	1.6±0.2	2.0±0.2	3.2±0.2
W	0.8±0.2	1.25±0.2	1.6±0.2
t	0.5±0.1	0.5±0.1	0.5±0.1
c	0.3±0.25	0.4±0.25	0.5±0.25
d	0.3±0.25	0.4±0.25	0.5±0.25

CONSTRUCTION

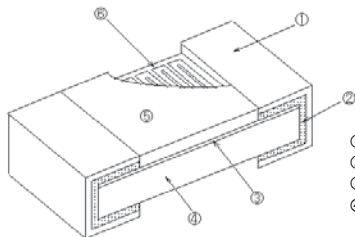

- ① External terminal (Sn)
- ② Internal terminal (Cu+Ni)
- ③ Bonding layer (polyimide)
- ④ Ceramic substrate (high-purity alumina)
- ⑤ Solder resist
- ⑥ Bulk Metal Foil

TCR, RESISTANCE RANGE, TOLERANCE, RATED POWER

Type	TCR -25°C to +125°C (ppm/°C)	Resistance Range (Ω)	Resistance Tolerance (%)	Rated Power at 70°C (W)
RWA	0±5	100 to 1k	±0.1(B)	0.1
		1k to 5k	±0.05(A)	
RWB	0±10	10 to 30	±0.5(D)	0.2
	0±5	30 to 100	±0.1(B)	
	0±2	100 to 1k 1k to 10k	±0.05(A), ±0.1(B) ±0.02(Q), ±0.05(A)	
RWC	0±10	5 to 30	±0.5(D)	0.3
	0±5	30 to 100	±0.1(B)	
	0±2	100 to 1k 1k to 30k	±0.02(Q), ±0.05(A), ±0.1(B) ±0.01(T), ±0.02(Q), ±0.05(A)	

POWER DERATING CURVE

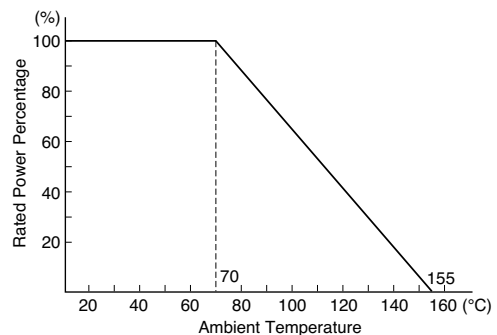

PERFORMANCE			
PARAMETERS	TEST CONDITION	SPECIFICATION	
		MIL-PRF-55342	ALPHA Typical
Max. Rated Operating Temperature		70°C	
Working Temperature Range		-65°C to +155°C	
Maximum Working Voltage		RWA=22V, RWB=45V, RWC=95V	
Thermal Shock	-65°C/30 min. ↔ +150°C/30 min. 100 cycles	±0.1%	±0.01%
Overloading	Rated Voltage x 2.5, 5 sec.	±0.1%	±0.01%
Low Temperature Storage	-65°C, No Load, 24 hrs. → Rated Power, 45 min.	±0.1%	±0.01%
Resistance to Soldering Heat	+260°C, 10 sec.	±0.2%	±0.01%
Moisture Resistance	+65°C to -10°C, 90% RH to 98% RH, Rated Voltage, 10 cycles (240 hrs.)	±0.2%	±0.02%
Life	70°C, Rated Power, 1.5 hrs. ON, 0.5 hrs. OFF, 2,000 hrs.	±0.5%	±0.005%
High Temperature Exposure	155°C, No Load, 100 hrs.	±0.1%	±0.02%

TAPE AND REEL PACKAGE (BASED ON EIA-481-1) [DIMENSIONS IN mm]

Tape Dimensions										Reel Dimensions						
Type	A	B	C	D	E	F	G	H	J	A	N	B	C	D	W1	W2
RWA	1.00 ±0.1	1.80 ±0.1	8.0 ±0.2	3.5 ±0.05	1.75 ±0.1	4.0 ±0.1	2.0 ±0.05	4.0 ±0.1	Dia. 1.55 ±0.55	Dia. 180 0/-1.5	Dia. 60 +1/0	Dia. 13 ±0.2	Dia. 21 ±0.8	2 ±0.5	9.0 +1/-0	13.0 ±1.0
RWB	1.45 ±0.1	2.25 ±0.1	8.0 ±0.2	3.5 ±0.05	1.75 ±0.1	4.0 ±0.1	2.0 ±0.05	4.0 ±0.1	Dia. 1.55 ±0.55	Reel Capacity RWA, RWB, RWC: 5,000 pieces/reel (Available at 100 pieces, 500 pieces and 1,000 pieces)						
RWC	1.90 ±0.1	3.50 ±0.1	8.0 ±0.2	3.5 ±0.05	1.75 ±0.1	4.0 ±0.1	2.0 ±0.05	4.0 ±0.1	Dia. 1.55 ±0.55							

PRECAUTION IN USING FACE-BONDED CHIP RESISTORS

1. Storage

Storage conditions or environment may adversely affect solderability of the exterior terminals. Do not store in high temperature and humidity. The recommended storage environment is lower than 40°C, has less than 70% RH humidity and is free from harmful gases such as sulphur and chlorine.

2. Caution in Soldering

- IR and vapor phase reflow are recommended.
- Vacuum pick up is recommended for handling.
- If the use of a soldering iron becomes necessary, precautionary measures should be taken to avoid any possible damage / overheating.

3. Cleaning

Avoid the use of cleaning agents which could attack epoxy resins, which form part of the resistor construction.

4. Recommended Land Pattern

The dimensions of solder land must be determined in conformity with the size of resistors and with the soldering method. They are also subject to the mounting machine and the material of the substrate.

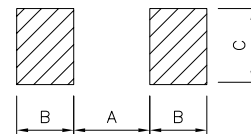

Type	A	B	C
RWA	0.8	0.9	1.0
RWB	0.8	1.2	1.4
RWC	1.6	1.5	1.8

(mm)

Z-Foil Ultra High-Precision SMT Resistor (Molded, J-Lead Terminal)

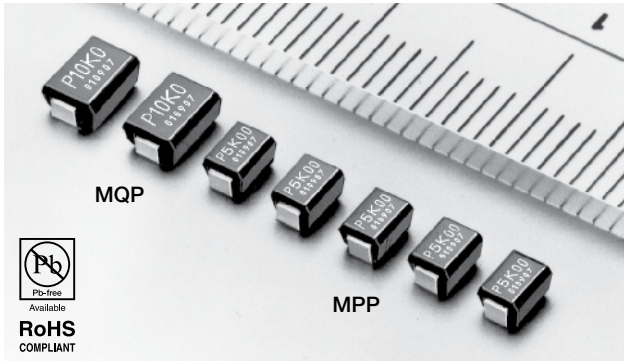

FEATURES	
•	Temperature coefficient of resistance (TCR): 0.05 ppm/°C typical (0°C to +60°C) by New Generation Z-Foil Technology
•	0.2 ppm/°C typical (-55°C to +125°C, +25°C ref.)
•	Resistance tolerance: to ±0.01%
•	Power coefficient “ΔR due to self heating”: 5 ppm at rated power (typical)
•	Power rating: to 200 mW (MPP) and 250 mW (MQP) at +70°C
•	Load life stability: to ±0.005% at 70°C, 2000h at rated power (typical)
•	Not restricted to standard values, we can supply specific “as required” values at no extra cost or delivery (e.g., 1K2345 vs. 1K)

COMPOSITION OF TYPE NUMBER	
Example:	
MPP	10K005* T L
	Resistance Value
	Resistance Tolerance
	Type
	Tape & Reel Package Required
Resistance value, in ohm, is expressed by a series of six characters, five of which represent significant digits. R or K is a dual-purpose letter that designates both the value range (R for ohmic; K for kilo-ohm) and the location of the decimal point.	
* Imprinting indicates up to 3 significant digits but ordered resistance value is traceable by date code	

TCR, RESISTANCE RANGE, TOLERANCE, RATED POWER				
Type	TCR (ppm/°C) -55°C to +125°C	Resistance Range (Ω)	Resistance Tolerance (%)	Rated Power (W) at 125°C
MPP	±0.2±3.8	30 to <50	±0.1(B)	0.1
	±0.2±2.8	50 to <100	±0.1(B)	
	±0.2±1.8	100 to <1k	±0.02(Q) ±0.05(A) ±0.1(B)	
		1k to ≤20k	±0.01(T) ±0.02(Q) ±0.05(A) ±0.1(B)	
MQP	±0.2±3.8	30 to <50	±0.1(B)	0.125
	±0.2±2.8	50 to <100	±0.1(B)	
	±0.2±1.8	100 to <1k	±0.02(Q) ±0.05(A) ±0.1(B)	
		1k to ≤40k	±0.01(T) ±0.02(Q) ±0.05(A) ±0.1(B)	

CONFIGURATION (DIMENSIONS IN mm)		
Type	MPP	MQP
L	3.2±0.2	4.5±0.2
W	2.5±0.2	3.2±0.2
H	2.0±0.2	
L1	0.6±0.2	0.8±0.2
W1	1.4±0.3	
W2	2.3±0.2	3.0±0.2
H1	1.5±0.3	
t	0.15±0.05	

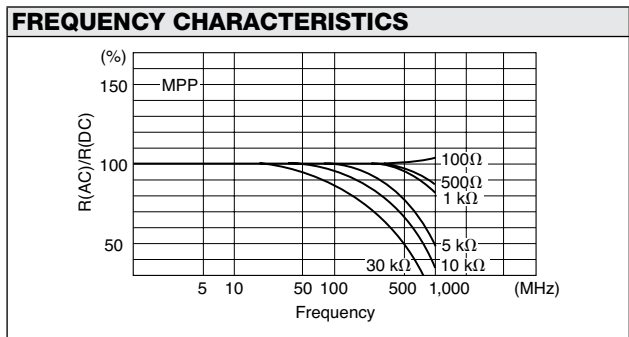
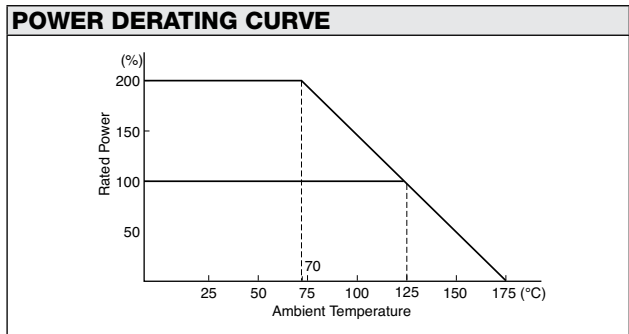

PERFORMANCE				
Parameters	Test Condition	Specification		Typical MPP/MQP
		MP/MQ	MPP/MQP	
Maximum Rated Operating Temperature Working Temperature Range Maximum Working Voltage Maximum Working Current			125°C -65°C to +175°C MPP = 50V, MQP = 100V 350 mA	
Thermal Shock Overload	-65°C/30 min. ↔ +150°C/30 min., 5 cycles Rated Voltage x 2.5, 5 sec.	±0.05%	±0.01%	±0.005%
Low Temperature Storage and Life Outstanding PC Board Bending	-65°C, No Load, 24 hrs. → Rated Voltage, 45 min. 3 mm Bend, 60 sec.	±0.05%	±0.01%	±0.005%
Dielectric Withstanding Voltage Insulation Resistance Resistance to Soldering Heat Moisture Resistance	AC 200V, 1 min. DC 100V, 1 min. 260°C, 10 sec. +65°C to -10°C, 90% RH to 98% RH, Rated Voltage, 10 cycles (240 hrs.)	±0.01%	±0.01%	±0.005%
Shock Vibration, High Frequency	100G, 6 ms, Sawtooth Wave, X, Y, Z, each 10 shocks 20G, 10 Hz to 2,000 Hz to 10 Hz, 20 min., X, Y, Z, each 2.5 hrs.	±0.02%	±0.02%	±0.01%
Storage Life	15°C to 35°C, 15% RH to 75% RH, No Load, 10,000 hrs.	±0.005%	±0.005%	±0.0025%
High Temperature Exposure	175°C, No Load, 2,000 hrs.	±0.05%	±0.05%	±0.03%
Life	70°C, Rated Power, 1.5 hr. – on, 0.5 hr. – off, 2,000 hrs. 70°C, Rated Power x 2, 1.5 hr. – on, 0.5 hr. – off, 2,000 hrs.	—	±0.01%	±0.005%
		—	±0.03%	±0.01%

TAPE AND REEL PACKAGE (BASED ON EIA-481-1) (DIMENSIONS IN mm)																	
Tape Dimensions										Reel Dimensions							
Type	A	B	C	D	E	F	G	H	J	A	N	B	C	D	W1	W2	r
MPP	2.8 ±0.2	3.9 ±0.2	12.0 ±0.3	5.5 ±0.05	1.75 ±0.1	4.0 ±0.1	2.0 ±0.05	4.0 ±0.1	Dia. 1.5 ±0.1-0	Dia. 178 ±2	Dia. 60 min.	Dia. 13 ±0.5	Dia. 21 ±0.8	2 ±0.5	12.4 +2.0-0	18.4 max.	1.0 ±0.5
MQP	3.6 ±0.2	5.2 ±0.2	12.0 ±0.3	5.5 ±0.05	1.75 ±0.1	8.0 ±0.1	2.0 ±0.05	4.0 ±0.1	Dia. 1.5 ±0.1-0	Reel Capacity		MPP: 1,200 pieces/reel MQP: 800 pieces/reel					

PRECAUTION IN USING FACE-BONDED CHIP RESISTORS

- Storage**
Storage conditions or environment may adversely affect solderability of the exterior terminals. Do not store in high temperature and humidity. The recommended storage environment is lower than 40°C, has less than 70% RH humidity and is free from harmful gases such as sulphur and chlorine.
- Caution in Soldering**
 - Hand Soldering**—Hand soldering is applicable as shown at right. Recommended
 - Temp. of iron tip: 240°C to 270°C
 - Power of iron: 20W or less
 - Diameter of tip: dia. 3 mm max.
 - Solder Reflow in Furnace**
Recommended
 - Peak temperature: 250+0/-5°C
 - Holding time: 10 sec. max.
 - To cool gradually at room temperature
 - Dipping in Solder (Wave or Still)**
Recommended
 - Temp. of solder: 260°C max
 - Length of dipping: 10 seconds
 - To cool gradually at room temperature
 - Other**
Corrosion-free flux, such as rosin, is recommended. Do not apply pressure to the molded housing immediately after soldering.
- Cleaning**
Use volatile cleaner such as methylalcohol or propyl alcohol.
- Circuit Board Design**
The dimensions of solder land must be determined in conformity with the size of resistors and with the soldering method. They are also subject to the mounting machine and the material of the substrate. See example below.

Type	A	B	C	D
MPP	1.6 to 2.0	0.5 to 1.5	2.2 to 2.6	1.8
MQP				2.5

When parts are mounted on a board in high density, solder can possibly attach to the resistors in an excessive amount to affect performance or reliability of the resistors. To prevent this effect, the use of solder resist is recommended to isolate solder lands.

Ultra Precision SMT Resistor (Molded, J-Lead Terminal)

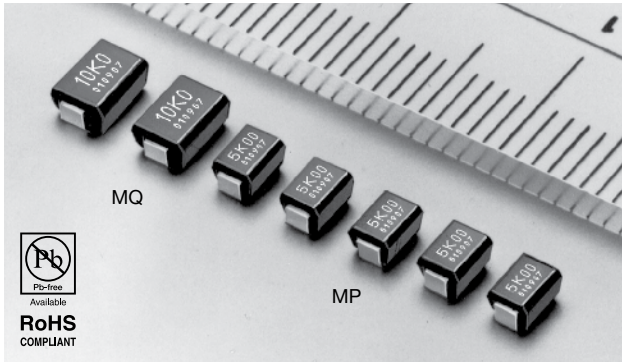

TCR, RESISTANCE RANGE, TOLERANCE, RATED POWER				
Type	TCR (ppm/°C) -55°C to +125°C	Resistance Range (Ω)	Resistance Tolerance (%)*	Rated Power (W) at 125°C
MP	0±10	30 to 100	±0.1	0.1
	0±5	100 to 30k	±0.05	
MQ	0±10	30 to 100	±0.1	0.125
	0±5	100 to 60k	±0.05	

* Please contact us for tighter tolerances.

COMPOSITION OF TYPE NUMBER

Example:
MQ 10K00 L

— Type & Reel Package Required
— Resistance Value
— Type

Resistance value, in ohm, is expressed by a series of five characters, four of which represent significant digits. R or K is a dual-purpose letter that designates both the value range (R for ohmic; K for kilo-ohm) and the location of the decimal point.

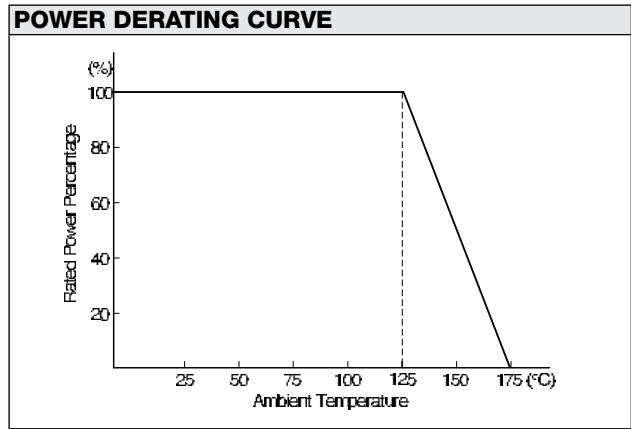

CONFIGURATION (DIMENSIONS IN mm)

Type	MP	MQ
L	3.2±0.2	4.5±0.2
W	2.5±0.2	3.2±0.2
H	2.0±0.2	
L1	0.6±0.2	0.8±0.2
W1	1.4±0.3	
W2	2.3±0.2	3.0±0.2
H1	1.5±0.3	
t	0.15±0.05	

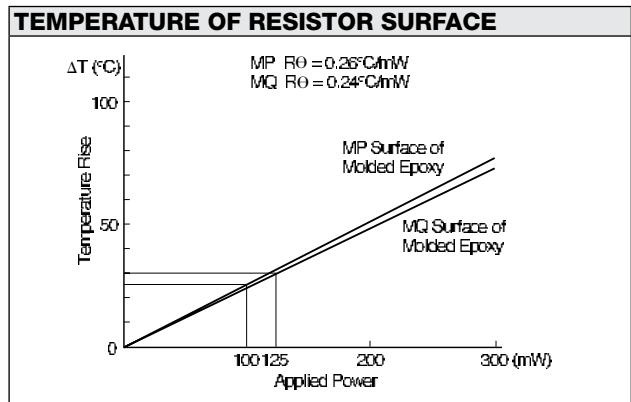
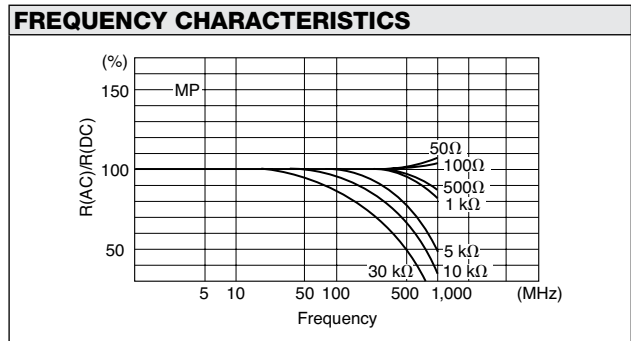

PERFORMANCE			
Parameters	Test Condition	ALPHA Specification	ALPHA Typical Test Data
Maximum Rated Operating Temperature Working Temperature Range Maximum Working Voltage Maximum Working Current			125°C -65°C to +175°C MP=50V, MQ=100V 350 mA
Thermal Shock Overload	-65°C/30 min. ↔ +175°C/30 min., 5 cycles Rated Voltage x 2.5, 5 sec.	±0.05% ±0.05%	±0.01% ±0.01%
Low Temperature Storage and Operation Substrate Bending Test	-65°C, No Load, 24 hrs. → Rated Voltage, 45 min. Substrate Bent 3 mm, 60 sec.	±0.05% ±0.05%	±0.01% ±0.01%
Dielectric Withstanding Voltage Insulation Resistance Resistance to Soldering Heat Moisture Resistance	Atmospheric: AC 200V, 1 min. DC 100V, 1 min. 260°C, 10 sec. +65°C to -10°C, 90% RH to 98% RH, Rated Voltage, 10 cycles (240 hrs.)	±0.01% over 10,000 MΩ ±0.05% ±0.05%	±0.005% over 10,000 MΩ ±0.01% ±0.03%
Shock Vibration, High Frequency	100G, 6 ms, Sawtooth Wave, X, Y, Z, each 10 shocks 20G, 10 Hz to 2,000 Hz to 10 Hz, 20 min., X, Y, Z, each 2.5 hrs.	±0.02% ±0.02%	±0.01% ±0.01%
Life	125°C, Rated Power, 1.5 hr. – ON, 0.5 hr. – OFF, 2,000 hrs.	±0.05%	±0.03%
Storage Life	15°C to 35°C, 15% RH to 75% RH, No Load, 10,000 hrs.	±0.005%	±0.0025%
High Temperature Exposure	175°C, No Load, 2,000 hrs.	±0.05%	±0.03%

TAPE AND REEL PACKAGE (BASED ON EIA-481-1) (DIMENSIONS IN mm)																	
Tape Dimensions										Reel Dimensions							
Type	A	B	C	D	E	F	G	H	J	A	N	B	C	D	W1	W2	r
MP	2.8 ±0.2	3.9 ±0.2	12.0 ±0.3	5.5 ±0.05	1.75 ±0.1	4.0 ±0.1	2.0 ±0.05	4.0 ±0.1	Dia. 1.5 ±0.1-0	Dia. 178 ±2	Dia. 60 min.	Dia. 13 ±0.5	Dia. 21 ±0.8	2 ±0.5	12.4 +2.0-0	18.4 max.	1.0 ±0.5
MQ	3.6 ±0.2	5.2 ±0.2	12.0 ±0.3	5.5 ±0.05	1.75 ±0.1	8.0 ±0.1	2.0 ±0.05	4.0 ±0.1	Dia. 1.5 ±0.1-0	Reel Capacity MP: 1,200 pieces/reel MQ: 800 pieces/reel							

PRECAUTION IN USING FACE-BONDED CHIP RESISTORS

- Storage**
Storage conditions or environment may adversely affect solderability of the exterior terminals. Do not store in high temperature and humidity. The recommended storage environment is lower than 40°C, has less than 70% RH humidity and is free from harmful gases such as sulphur and chlorine.
- Caution in Soldering**
 - Hand Soldering**
Hand soldering is applicable as shown at right.
Recommended
 - Temp. of iron tip: 240°C to 270°C
 - Power of iron: 20W or less
 - Diameter of tip: dia. 3 mm max.
 - Solder Reflow in Furnace**
Recommended
 - Peak temperature: 250+0/-5°C
 - Holding time: 10 sec. max.
 - To cool gradually at room temperature
 - Dipping in Solder (Wave or Still)**
Recommended
 - Temp. of solder: 260°C max
 - Length of dipping: 10 seconds
 - To cool gradually at room temperature
 - Other**
Corrosion-free flux, such as rosin, is recommended. Do not apply pressure to the molded housing immediately after soldering.
- Cleaning**
Use volatile cleaner such as methylalcohol or propyl alcohol.
- Circuit Board Design**
The dimensions of solder land must be determined in conformity with the size of resistors and with the soldering method. They are also subject to the mounting machine and the material of the substrate. See example below.

Type	A	B	C	D
MP	1.6 to 2.0	0.5 to 1.5	2.2 to 2.6	1.8
MQ				2.5

Dimensions in mm

When parts are mounted on a board in high density, solder can possibly attach to the resistors in an excessive amount to affect performance or reliability of the resistors. To prevent this effect, the use of solder resist is recommended to isolate solder lands.

PERFORMANCE					
Parameters	Test Condition	ALPHA Specification		ALPHA Typical Test Data	
		Δ R	Δ Ratio	Δ R	Δ Ratio
Maximum Rated Operating Temperature Working Temperature Range		125°C -65°C to +150°C			
Thermal Shock Overload	-65°C/30 min. ↔ +150°C/30 min., 5 cycles Rated Voltage x 2.5, 5 sec.	±0.05% ±0.05%	±0.02% ±0.02%	±0.01% ±0.01%	±0.005% ±0.005%
Low Temperature Storage and Operation Substrate Bending Test	-65°C, No Load, 24 hrs. → Rated Voltage, 45 min. 3 mm Bend 60 sec.	±0.05% ±0.05%	±0.02% ±0.02%	±0.01% ±0.01%	±0.005% ±0.005%
Dielectric Withstanding Voltage Insulation Resistance Resistance to Soldering Heat Moisture Resistance	Atom. Pres.: AC 200V, 1 min. DC 100V, 1 min. 260°C, 10 sec. +65°C to -10°C, 90% to 98% RH, Rated Power, 10 cycles (240 hrs.)	±0.01% ±0.05%	±0.01% ±0.02%	±0.005% ±0.03%	±0.0025% ±0.01%
Shock Vibration, High Frequency	100G, 6 ms, Sawtooth Wave, X, Y, Z, each 10 shocks 20G, 10 Hz to 2,000 Hz to 10 Hz, 20 min., X, Y, Z, each 2.5 hrs.	±0.02% ±0.02%	±0.01% ±0.01%	±0.01% ±0.01%	±0.005% ±0.005%
Life	125°C, Rated Power, 1.5 hrs. – ON, 0.5 hrs. – OFF, 2,000 hrs.	±0.05%	±0.02%	±0.03%	±0.015%
Storage Life	15°C to 35°C, 15% RH to 75% RH, No Load, 10,000 hrs.	±0.005%	±0.0025%	±0.0025%	±0.0015%
High Temperature Exposure	150°C, No Load, 2,000 hrs.	±0.05%	±0.02%	±0.02%	±0.01%

TAPE AND REEL PACKAGE (BASED ON EIA-481-1) (DIMENSIONS IN mm)

Tape Dimensions										Reel Dimensions (Reel capacity: 800 pieces/reel)							
Type	A	B	C	D	E	F	G	H	J	A	N	B	C	D	W ₁	W ₂	r
MU	3.6 ±0.2	3.1 ±0.2	12.0 ±0.3	5.5 ±0.05	1.75 ±0.1	8.0 ±0.1	2.0 ±0.05	4.0 ±0.1	Dia. 1.5 +0.1-0	Dia. 178 ±2	Dia. 60 min.	Dia. 13 ±0.5	Dia. 21 ±0.8	2 ±0.5	12.4 +2.0-0	18.4 max.	1.0 ±0.5

PRECAUTION IN USING FACE-BONDED CHIP RESISTOR (DIMENSIONS IN mm)

1. Storage

Storage condition or environment may adversely affect solderability of the exterior terminals. Do not store in high temperature and humidity. The recommended storage environment is lower than 40°C, has less than 70% RH humidity and is free from harmful gases such as sulphur and chlorine.

2. Caution in Soldering

① Hand Soldering

- Hand soldering is applicable as shown at right.
- Recommended
 - Temp. of Iron Tip: 240°C to 270°C
 - Power of Iron: 20W or less
 - Diameter of Tip: Dia. 3 mm max.

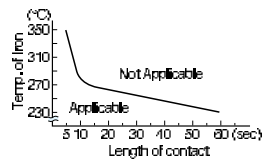

② Solder Reflow in Furnace

- Recommended
 - Peak Temperature: 250°C +0°C/-5°C
 - Holding time: 10 sec. max.
 - To cool gradually at room temperature

③ Dipping in Solder (Wave or Still)

- Recommended
 - Temp. of Solder: 240°C to 250°C
 - Length of Dipping: 3 to 4 seconds
 - To cool gradually at room temperature

④ Other

Corrosion-free flux, such as rosin, is recommended. Do not apply pressure to the molded housing immediately after soldering.

3. Cleaning

Use volatile cleaner such as methylalcohol or propylalcohol.

4. Circuit Board Design

The dimensions of solder land must be determined in conformity with the size of resistors and with the soldering method. They are also subject to the mounting machine and the material of the substrate. See example below.

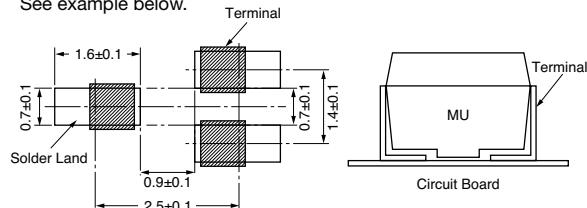

When parts are mounted on a board in high density, solder can possibly attach to the resistors in an excessive amount to affect performance or reliability of the resistors. To prevent this effect, the use of solder resist is recommended to isolate solder lands.

Ultra Precision SMT Current Sense Resistor (Flip-Chip)

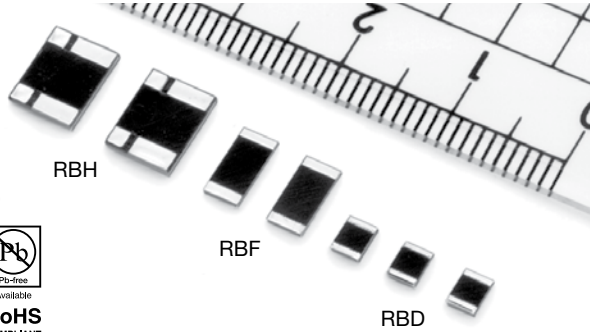

TCR, RESISTANCE RANGE, TOLERANCE, RATED POWER				
Type	TCR (ppm/°C) -25°C to 125°C*	Resistance Range (Ω)	Resistance Tolerance (%)*	Rated Power (W) at 70°C
RBD	0±25 (J)	0.01 to 0.1	±1 (F) ±2 (G) ±5 (J)	0.5
	0±10 (C) 0±25 (J)	0.1 to 1	±0.5 (D) ±1 (F) ±2 (G) ±5 (J)	
RBF	0±25 (J)	0.01 to 0.1	±1 (F) ±2 (G) ±5 (J)	1
	0±10 (C) 0±25 (J)	0.1 to 1	±0.5 (D) ±1 (F) ±2 (G) ±5 (J)	
RBH	0±10 (C) 0±25 (J)	0.01 to 0.1	±0.5 (D) ±1 (F) ±2 (G) ±5 (J)	1.5

*Symbols parenthesized are for type number composition.

COMPOSITION OF TYPE NUMBER

Example:

RBF J R1000 F L

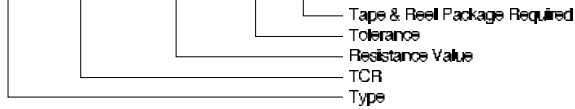

Resistance value in ohm is expressed by a series of four significant digits and an R designates the decimal point.

POWER DERATING CURVE

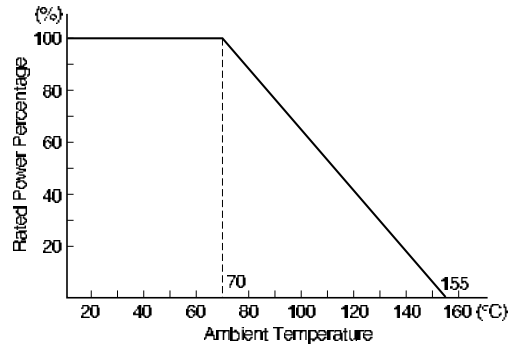

CONFIGURATION (DIMENSIONS IN mm)

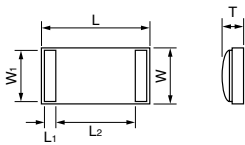

Type	RBD	RBF
L	3.2±0.1	6.3±0.1
W	2.5±0.1	3.2±0.1
L ₁	0.5±0.2	0.7±0.2
L ₂	2.1±0.2	4.7±0.2
W ₁	2.4±0.2	3.0±0.2
T	1.05 max.	

Dimensions in mm

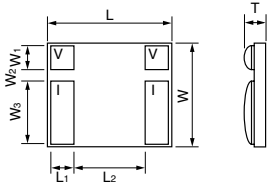

Type	RBH
L	7.5±0.1
W	6.0±0.1
L ₁	1.4±0.2
L ₂	4.4±0.2
W ₁	1.4±0.2
W ₂	0.7±0.2
W ₃	3.6±0.2
T	1.5 max.

Dimensions in mm

I: Current Sensing Terminal
V: Voltage Terminal

TEMPERATURE OF RESISTOR SURFACE

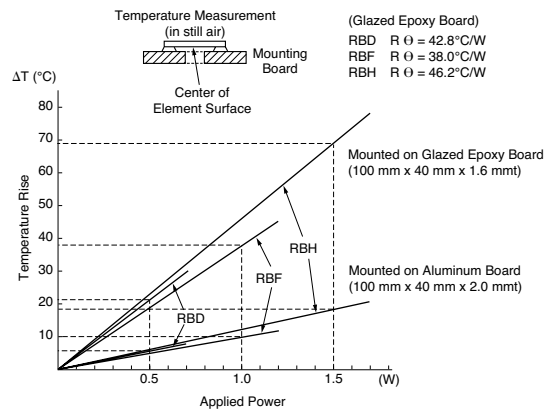

Please use board made of metal for continuous use with 2W at 70°C. Please keep the temperature of board less than 90°C when using the glazed epoxy board.

CONSTRUCTION

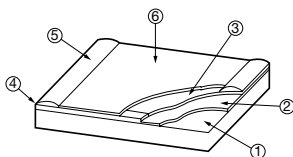

- ① Ceramic Substrate (High-Purity Alumina)
- ② Heat-Resistant Bonding Layer
- ③ Bulk Metal® Foil
- ④ Metal Plating
- ⑤ Solder
- ⑥ Solder-Resist

PERFORMANCE			
Parameters	Test Condition	ALPHA Specification	ALPHA Typical Test Data
Maximum Rated Operating Temperature Working Temperature Range		70°C -65°C to +155°C	
Thermal Shock Overload	-65°C/30 min. ↔ +155°C/30 min., 5 cycles Rated Power x 2.5, 5 sec.	±0.1% ±0.1%	±0.03% ±0.03%
Low Temperature Storage and Operation Substrate Bending Test	-65°C, No Load, 24 hrs. → Rated Voltage, 45 min. Substrate Bent 3 mm, 60 sec.	±0.1% ±0.1%	±0.05% ±0.05%
Dielectric Withstanding Voltage Insulation Resistance Resistance to Soldering Heat Moisture Resistance	Atmo. Pres.: AC 200V, 1 min. DC 100V, 1 min. 260°C, 10 sec. +65°C to -10°C, 90% RH to 98% RH, Rated Voltage, 10 cycles (240 hrs.)	±0.05% over 10,000 MΩ ±0.1% ±0.1%	±0.01% over 10,000 MΩ ±0.03% ±0.03%
Shock Vibration, High Frequency	100G, 6 ms, Sawtooth Wave, X, Y, Z, each 10 shocks 20G, 10 Hz to 2,000 Hz to 10 Hz, 20 min., X, Y, Z, each 2.5 hrs.	±0.05% ±0.05%	±0.01% ±0.01%
Life	70°C, Rated Power, 1.5 hr. – ON, 0.5 hr. – OFF, 2,000 hrs	±0.1%	±0.05%
Storage Life	15°C to 35°C, 15% RH to 75% RH, No Load, 10,000 hrs.	±0.05%	±0.01%
High Temperature Exposure	155°C, No Load, 2,000 hrs.	±0.1%	±0.05%

TAPE AND REEL PACKAGE (BASED ON EIA-481-1) (DIMENSIONS IN mm)

Tape Dimensions										Reel Dimensions								
										Reel Capacity RBH: 1,000 pieces/reel RBD, RBF: 4,000 pieces/reel 								
RBD, RBF: 0.25±0.05 RBH: 0.30±0.05 RBD, RBF: 1.2±0.1 RBH: 1.80±0.1																		
Type	A0	B0	W	F	E	P1	P2	P0	D0	Type	A	N	B	C	D	W1	W2	r
RBD	2.85 ±0.1	3.7 ±0.1	8.0 ±0.2	3.5 ±0.05	1.75 ±0.1	4.0 ±0.1	2.0 ±0.05	4.0 ±0.1	Dia.1.5 +0.1-0	RBD	Dia.178 ±2	Dia.60 min.	Dia.13 ±0.5	Dia.21 ±0.8	2.0 ±0.5	8.4 +2.0-0	14.4 max.	1.0 ±0.5
RBF	3.4 ±0.1	6.7 ±0.1	12.0 ±0.2	5.5 ±0.05	1.75 ±0.1	4.0 ±0.1	2.0 ±0.05	4.0 ±0.1	Dia.1.5 +0.1-0	RBF	Dia.178 ±2	Dia.60 min.	Dia.13 ±0.5	Dia.21 ±0.8	2.0 ±0.5	12.4 +2.0-0	18.4 max.	1.0 ±0.5
RBH	6.3 ±0.1	7.8 ±0.1	16.0 ±0.2	7.5 ±0.1	1.75 ±0.1	8.0 ±0.1	2.0 ±0.1	4.0 ±0.1	Dia.1.5 +0.1-0	RBH	Dia.178 ±2	Dia.60 min.	Dia.13 ±0.5	Dia.21 ±0.8	2.0 ±0.5	17.0 ±0.3	19.4 ±0.1	1.0 ±0.5

PRECAUTION IN USING SMD CURRENT SENSE RESISTORS

1. Storage

Storage condition or environment may adversely affect solderability of the exterior terminals. Do not store in high temperature and humidity. The recommended storage environment is lower than 40°C, has less than 70% RH humidity and is free from harmful gases such as sulphur and chlorine.

2. Caution in Soldering

- ① Solder Reflow in Furnace Recommended
 - Peak Temperature: 250+0/-5°C
 - Holding time: 10 sec. max.
 - To cool gradually at room temperature.
- ② Dipping in Solder (Wave or Still) Recommended
 - Temp. of Solder: 260°C max.
 - Length of Dipping: 10 sec.

③ Other
Soldering iron is never recommended. Corrosion-free flux such as rosin is recommended.

3. Cleaning

Use volatile cleaner such as methylalcohol or propylalcohol.

4. Circuit Board Design

- ① Solder Land Dimensions
The dimensions of solder land must be determined in conformity with the size of resistors and with the soldering method. They are also subject to the mounting machine and the material of the substrate. See example at right.

RBD, RBF

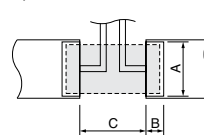

RBH

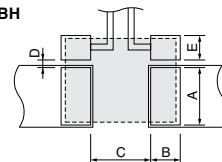

Type	Dimensions in mm				
	A	B	C	D	E
RBD	2.6 to 2.8	0.8	2.0	/	/
RBF	3.4 to 3.6	1.2	4.5		
RBH	3.8 to 4.0	2.0	4.0		

② Circuit Design

It is recommended that the circuit be drawn so that current may approach, cross and go away from the mounted resistor in one direction as illustrated below. Thicker copper foil should be used if possible.

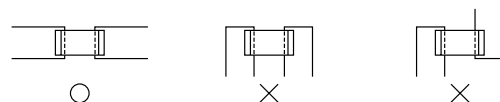

Ultra Precision Resistor (Transfer Molded)

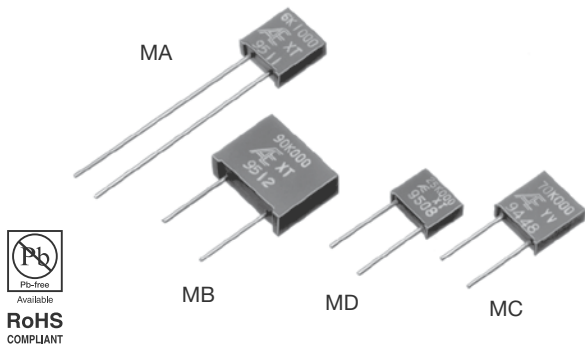

COMPOSITION OF TYPE NUMBER

Example:
MA Y 10K000 A

└─ Tolerance
└─ Resistance Value
└─ TCR
└─ Type

Resistance value, in ohm, is expressed by a series of six characters, five of which represent significant digits. R or K is a dual-purpose letter that designates both the value range (R for ohmic; K for kilo-ohm) and the location of decimal point.

TCR, RESISTANCE RANGE, TOLERANCE, RATED POWER				
Type	TCR (ppm/°C) -55°C to +125°C*	Resistance Range (Ω)	Resistance Tolerance (%)†‡	Rated Power (W) at 125°C
MA MC	0±15 (W)	1 to 5	±0.5 (D) ±1 (F)	0.3 (0.2 at 150 kΩ or above)
	0±5 (X)	5 to 30	±0.1 (B) ±0.5 (D) ±1 (F)	
	0±5 (X) 0±2.5 (Y) 0±1 (Z)**	30 to 200k	±0.005 (V) ±0.01 (T) ±0.02 (Q) ±0.05 (A) ±0.1 (B) ±0.5 (D) ±1 (F)	
MB	0±5 (X)	5 to 30	±0.1 (B) ±0.5 (D) ±1 (F)	0.5 (0.3 at 200 kΩ or above)
	0±5 (X) 0±2.5 (Y) 0±1 (Z)**	30 to 400k	±0.005 (V) ±0.01 (T) ±0.02 (Q) ±0.05 (A) ±0.1 (B) ±0.5 (D) ±1 (F)	
MD	0±5 (X)	5 to 30	±0.1 (B) ±0.5 (D) ±1 (F)	0.125
	0±5 (X) 0±2.5 (Y)	30 to 100	±0.05 (A) ±0.1 (B) ±0.5 (D) ±1 (F)	
	0±5 (X) 0±2.5 (Y) 0±1 (Z)**	100 to 80k	±0.01 (T) ±0.02 (Q) ±0.05 (A) ±0.1 (B) ±0.5 (D) ±1 (F)	

* Symbols in parentheses are for type number composition.

† Resistance figures are the values obtained by measuring the leads at point 12.7±3.2 mm away from the base for Type MA and at point 5.0±1.0 mm for Types MC, MB and MD, but, in case of resistance below 10 ohm, the value at 1.6±0.6 mm away from the base for all types.

**Temperature characteristic Z is applicable for temperature range between 0°C and 60°C.

CONFIGURATION (DIMENSIONS IN mm)

Type	MA	MC	MB	MD
L	7.9±0.2		13.0±0.3	7.4±0.2
L1	1.0 max.		1.5 max.	0.8 max.
W	8.3±0.2		10.0±0.3	6.0±0.2
W1	8.0±0.2		9.5±0.3	5.7±0.2
W2	0.3 max.		0.5 max.	0.4 max.
T	2.8±0.2	2.3±0.2	4.0±0.3	2.3±0.2
F	3.81±0.25	5.08±0.25	7.5±0.5	5.08±0.25
l	25±10		10±3	
d	Dia. 0.65±0.05			

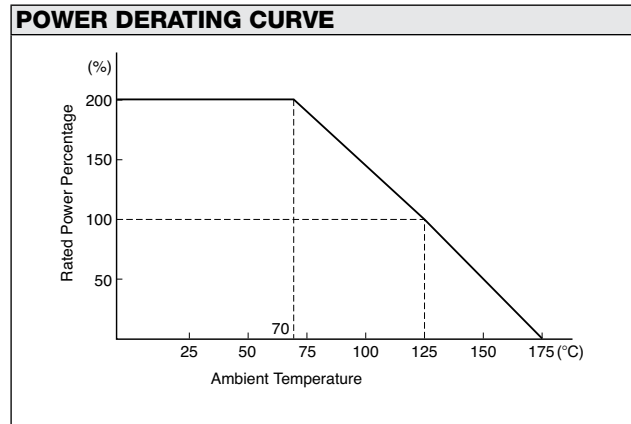

DSCC SPECIFICATIONS

97009
97010
97011

PERFORMANCE			
Parameters	Test Condition	MIL-PRF-55182/9 Specification	ALPHA Typical Test Data
Maximum Rated Operating Temperature Working Temperature Range Maximum Working Voltage			125°C -65°C to +175°C MA, MC=300V, MB=350V, MD=250V
Power Conditioning Thermal Shock Overload	125°C, Rated Power, 100 hrs. -65°C/30 min. ↔ +150°C/30 min., 5 cycles Rated Power x 6.25, 5 sec.	±(0.20%+0.01Ω) ±0.05% ±0.05%	±0.005% ±0.005% ±0.005%
Solderability Resistance to Solvents	Steam Aging 8 hrs., 245°C, 5 sec. ☉ Isopropyl Alcohol + Mineral Spirits ☉ Water + Butyl Cellosolve + Monoethanolamine	over 95% coverage no damage	over 95% coverage no damage
Low Temperature Storage Low Temperature Operation Terminal Strength	-65°C, 24 hrs. -65°C, Rated Voltage, 45 min. 0.908 kg (2 pounds), 10 sec	±0.05% ±0.05% ±0.02%	±0.0025% ±0.0025% ±0.0025%
Dielectric Withstanding Voltage Insulation Resistance Resistance to Soldering Heat Moisture Resistance	Atmo.Pres.: 300V rms. Baro. Pres. 8 mHg: 200V rms. DC 100V, 2 min. +260°C, 10 sec. +65°C to -10°C, 90% RH to 98% RH, Rated Voltage, 10 cycles (240 hrs.)	±0.02% over 10,000 MΩ ±0.02% ±0.05%	±0.0025% over 10,000 MΩ ±0.0025% ±0.01%
Shock (Specified Pulse) Vibration, High Frequency	100G, 6 ms, Sawtooth Wave, X, Y, each 10 shocks 20G, 10 Hz to 2,000 Hz to 10 Hz, 20min., X, Y, each 4 hrs.	±0.01% ±0.02%	±0.0025% ±0.0025%
Life	125°C, Rated Voltage, 1.5 hr. – ON, 0.5 hr. – OFF, 2,000 hrs.	±0.05%	±0.015%
Life 70°C Power Rating	70°C, Rated Voltage x 2, 1.5 hr. – ON, 0.5 hr. – OFF, 2,000 hrs.	±0.05%	±0.015%
Storage Life	15°C to 35°C, 15% RH to 75% RH, No Load, 10,000 hrs.	±0.005%	±0.0025%
High Temperature Exposure	175°C, No Load, 2,000 hrs.	±0.5%	±0.015%
Current Noise Voltage Coefficient Thermal EMF		-32 dB 0,0005%/V 1.0 μV/°C	-42 dB 0,00003%/V 1.0 μV/°C

Type MA meets requirements of MIL-PRF-55182/9.

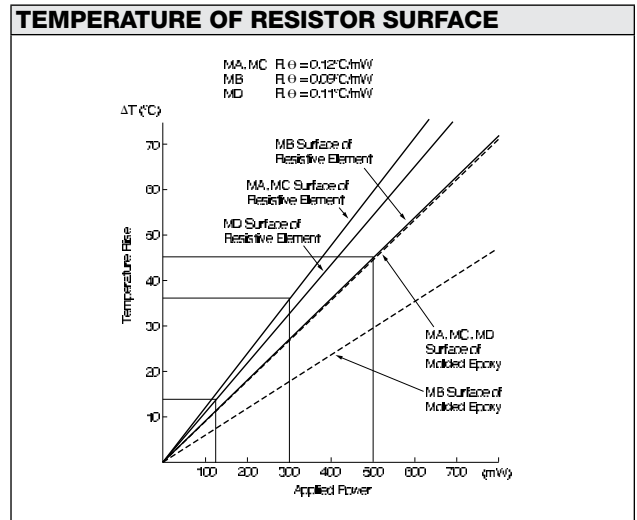
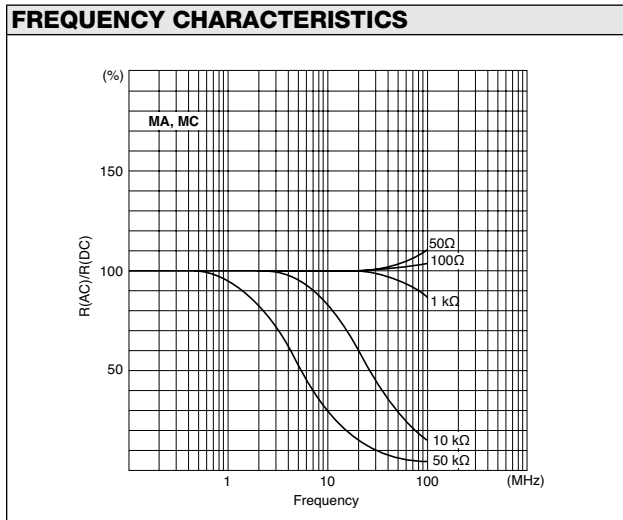

Precision Resistor (Conformally Coated)

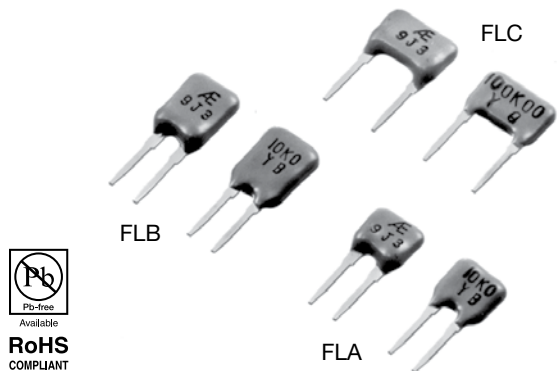

RoHS COMPLIANT

TCR, RESISTANCE RANGE, TOLERANCE, RATED POWER				
Type	TCR (ppm/°C) -25°C to +125°C*	Resistance Range (Ω)	Resistance Tolerance (%)†	Rated Power (W) at 70°C
FLA	0±5 (X) 0±2.5 (Y)	10 to 30	±0.5 (D) ±1.0 (F)	0.125
		30 to 100	±0.1 (B) ±0.5 (D)	
		100 to 100k	±0.05 (A) ±0.1 (B)	
FLB	0±5 (X) 0±2.5 (Y)	10 to 30	±0.5 (D) ±1.0 (F)	0.25
		30 to 100	±0.1 (B) ±0.5 (D)	
		100 to 150k	±0.05 (A) ±0.1 (B)	
FLC	0±5 (X) 0±2.5 (Y)	10 to 30	±0.5 (D) ±1.0 (F)	0.25
		30 to 100	±0.02 (Q) ±0.05 (A) ±0.1 (B) ±0.5 (D)	
		100 to 200k	±0.01 (T) ±0.02 (Q) ±0.05 (A) ±0.1 (B)	

* Symbols parenthesized are for type number composition.
† Resistance figures are the values obtained by measuring at the point 2.5±1.0 mm below the shoulder of leads.

COMPOSITION OF TYPE NUMBER

Example:
FLA X 500R00 B

Diagram showing the breakdown of the type number: FLA (Type), X (TCR), 500R00 (Resistance Value), B (Tolerance).

Resistance value, in ohm, is expressed by a series of six characters, five of which represent significant digits. R or K is a dual-purpose letter that designates both the value range (R for ohmic; K for kilo-ohm) and the location of decimal point.

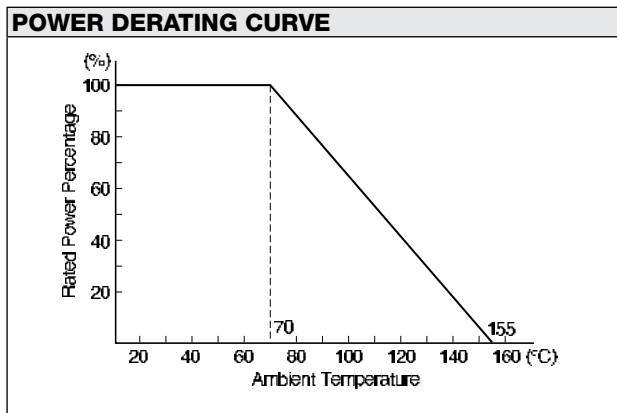

CONFIGURATION (DIMENSIONS IN mm)

Type	FLA	FLB	FLC
L	5.6±0.5		7.5±0.5
W	6.2±0.5	8.2±0.5	6.2±0.5
T	2.2±0.5		
F	2.54±0.25		5.08±0.25
l	5±1		
t	0.3±0.05		
a	1.0±0.05		
b	0.65±0.05		
c	0.4±0.05		

PERFORMANCE			
Parameters	Test Condition	ALPHA Specification	ALPHA Typical Test Data
Maximum Rated Operating Temperature Working Temperature Range Maximum Working Voltage			70°C -25°C to +155°C FLA=250V, FLB/FLC=300V
Temperature Cycling Overload	-25°C/30 min., Room Temperature/5 min., +155°C/30 min., 5 cycles Rated Voltage x 2.5, 5 sec.	±0.05% ±0.05%	±0.01% ±0.0025%
Solderability Resistance to Solvents	235°C, 2 sec. ① Isopropyl Alcohol ② Trichloroethylene	over 75% coverage no damage	over 75% coverage no damage
Low Temperature Storage Terminal Strength	-25°C, No Load, 2 hrs. 0.908 kg (2 pounds), 10 sec.	±0.05% ±0.05%	±0.0025% ±0.0025%
Dielectric Withstanding Voltage Insulation Resistance Resistance to Soldering Heat Moisture Resistance	Atmo. Pres.: AC 300V, 1 min. DC 100V, 1 min. 350°C, 3 sec. +65°C to -10°C, 90% RH to 98% RH, Rated Voltage, 10 cycles (240 hrs.)	±0.03% over 10,000 MΩ ±0.03% ±0.1%	±0.0025% over 10,000 MΩ ±0.0025% ±0.015%
Shock Vibration	50G, 11 ms, Half-Sine Wave, X, Y, Z, each 3 shocks 20G, 10 Hz to 55 Hz to 10 Hz, 1 min., X, Y, Z, each 2 hrs.	±0.03% ±0.03%	±0.005% ±0.005%
Life (Rated Load)	70°C, Rated Power, 1.5 hr. – ON, 0.5 hr. – OFF, 1,000 hrs.	±0.1%	±0.01%
Life (Moisture Load)	40°C, 90% RH to 95% RH, Rated Power, 1.5 hr. – ON, 0.5 hr. – OFF, 1,000 hrs.	±0.05%	±0.01%
Storage Life	15°C to 35°C, 15% RH to 75% RH, No Load, 10,000 hrs.	±0.02%	±0.005%
High Temperature Exposure	155°C, No Load, 1,000 hrs.	±0.05%	±0.01%
Current Noise Pressure Cooker Test	121°C, 100% RH, 2 atmospheric, No Load, 100 hrs.	-25 dB ±0.5%	-42 dB ±0.1%

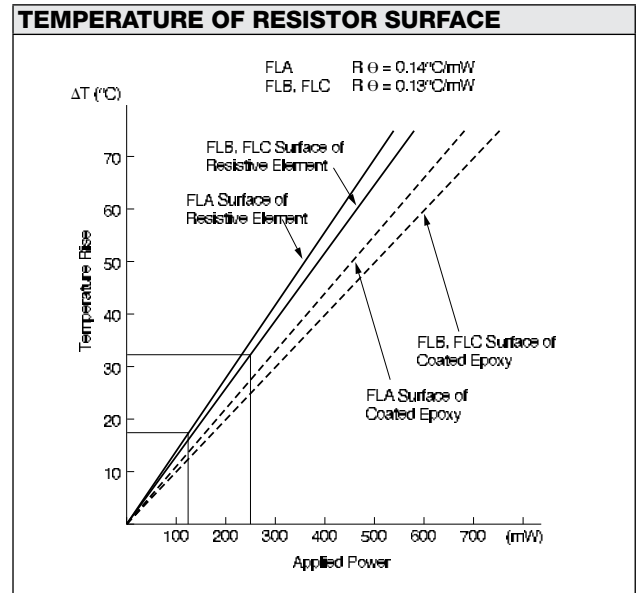
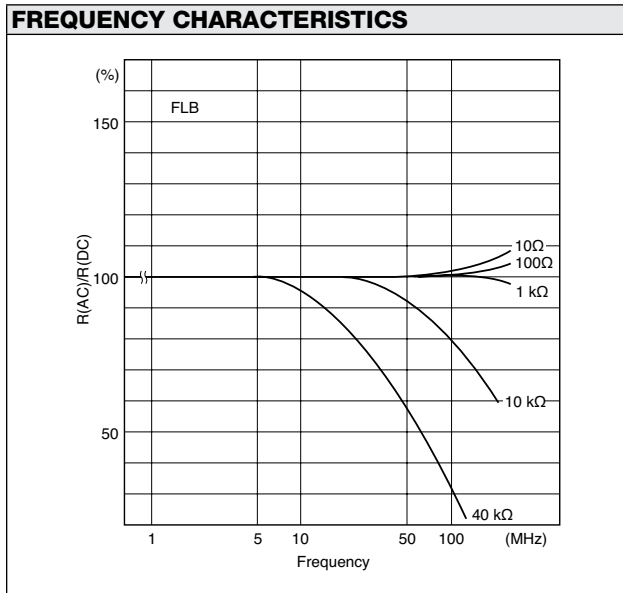

Ultra Precision Resistor 1-2-3 Network

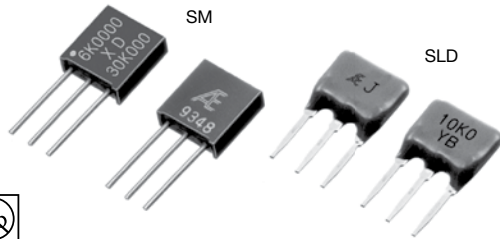

RoHS COMPLIANT

DSCC Specification 87026

TCR, RESISTANCE RANGE, TOLERANCE, RATED POWER

Type	TCR (ppm/°C) -55°C to +125°C**		Resistance Range/Element (Ω)***	Resistance Tolerance (%)		Rated Power/Package (W) at 125°C
	Absolute*	Tracking		Absolute*	Matching*	
SM	0±5 (X) 0±2.5 (Y)	See Table 1	50 to 30k	±0.02 (Q) ±0.05 (A) ±0.1 (B)	±0.01 (T) ±0.02 (Q) ±0.05 (A) ±0.1 (B)	0.3
SLD	0±5 (X) 0±2.5 (Y)	See Table 1	50 to 100	±0.1 (B) ±0.5 (D)	±0.05 (A) ±0.1 (B)	0.25 at 70°C
			100 to 30k	±0.05 (A) ±0.1 (B)	±0.02 (Q) ±0.05 (A) ±0.1 (B)	

* Symbols parenthesized are for type number composition.

** -25°C to +125°C for SLD type.

*** Please contact us for the availability.

COMPOSITION OF TYPE NUMBER

Example: R=FR

SM 1X 10K00 B A

① ②③ ④ ⑤ ⑥

Example: R=FR

SLD 2X 1K000 / 10K00 B Q

① ②③ ④ ⑤ ⑥

- ① Type
- ② Number of Values
- ③ TCR Absolute
- ④ Nominal Resistance Values
- ⑤ Resistance Tolerance (Absolute)
- ⑥ Resistance Tolerance (Matching)

Resistance value, in ohm, is expressed by a series of five characters, four of which represent significant digits. The fifth R or K is a dual-purpose letter that designates both the value range (R for ohmic; K for kilo-ohm) and the location of decimal point.

TABLE 1. TCR TRACKING IS SUBJECT TO RESISTANCE RATIO

Resistance Ratio	TCR Tracking (ppm/°C)
Resistance Ratio = 1	±0.5
1 < Resistance Ratio ≤ 10	±1
10 < Resistance Ratio ≤ 100	±2
100 < Resistance Ratio	±3

CONFIGURATION (DIMENSIONS IN mm)

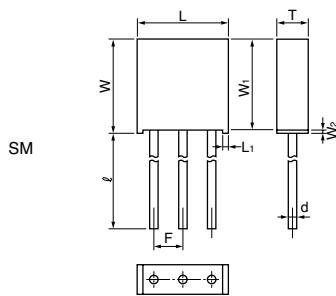

Type	SM
L	7.7±0.2
L1	1.0 max.
W	8.1±0.2
W1	7.8±0.2
W2	0.3 max.
T	2.6±0.2
F	2.54±0.25
l	10±3
d	φ0.65±0.05

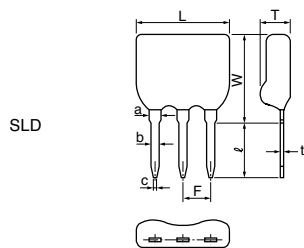

Type	SLD
L	7.5±0.5
W	7.5±0.5
T	2.2±0.5
F	2.54±0.25
l	5±1
t	0.3±0.05
a	1.0±0.05
b	0.65±0.05
c	0.4±0.05

POWER DERATING CURVE

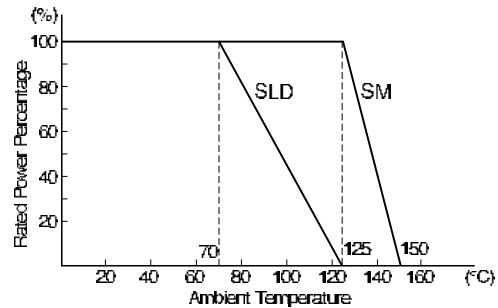

FREQUENCY CHARACTERISTICS

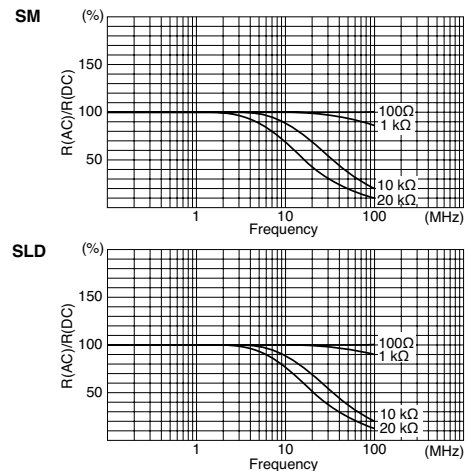

PERFORMANCE – SM					
Parameters	Test Condition	ALPHA Specification		ALPHA Typical Test Data	
		ΔR	Δ Ratio	ΔR	Δ Ratio
Maximum Rated Operating Temperature Working Temperature Range		125°C -65°C to +150°C			
Thermal Shock Overload	-65°C/30 min.↔ +150°C/30 min., 5 cycles Rated Voltage x 2.5, 5 sec.	±0.02% ±0.02%	±0.01% ±0.01%	±0.005% ±0.0025%	±0.0025% ±0.001%
Solderability	245°C, 5 sec.	over 95% coverage		over 95% coverage	
Resistance to Solvents	① Isopropyl Alcohol + Mineral Spirits ② Water + Butyl Cellosolve + Monoethanolamine	no damage		no damage	
Low Temperature Storage and Operation Terminal Strength	-65°C, No Load, 24 hrs.→Rated Voltage, 45 min. 0.908 kg (2 pounds), 10 sec.	±0.05% ±0.02%	±0.02% ±0.01%	±0.0025% ±0.0025%	±0.001% ±0.001%
Dielectric Withstanding Voltage Insulation Resistance	Atmo. Pres.: AC 300V, 1 min. Baro. Pres.: 1066 Pa; AC 200V, 1min. DC 500V, 2 min.	±0.02%	±0.01%	±0.0025%	±0.001%
Resistance to Soldering Heat Moisture Resistance	350°C, 3 sec. +65°C to -10°C, 90% RH to 98% RH, Rated Voltage, 10 cycles (240 hrs.)	over 10,000 M Ω		over 10,000 M Ω	
Shock Vibration, High Frequency	100G, 6 ms, Sawtooth Wave, X, Y, Z, each 10 shocks 20G, 10 Hz to 2,000 Hz to 10 Hz, 20 min., X, Y, Z, each 2.5 hrs.	±0.01% ±0.02%	±0.005% ±0.01%	±0.0025% ±0.0025%	±0.001% ±0.001%
Life	125°C, Rated Power, 1.5 hr. – ON, 0.5 hr. – OFF, 2,000 hrs.	±0.05%	±0.02%	±0.015%	±0.005%
Storage Life	15°C to 35°C, 15% RH to 75% RH, No Load, 10,000 hrs.	±0.005%	±0.0025%	±0.0025%	±0.0015%
High Temperature Exposure	150°C, No Load, 2,000 hrs.	±0.05%	±0.02%	±0.015%	±0.005%
Current Noise Voltage Coefficient Thermal EMF		-32 dB 0.0005%/V 1.0 μ V/°C		-42 dB 0.00003%/V 1.0 μ V/°C	

PERFORMANCE – SLD					
Parameters	Test Condition	ALPHA Specification		ALPHA Typical Test Data	
		ΔR	Δ Ratio	ΔR	Δ Ratio
Maximum Rated Operating Temperature Working Temperature Range		70°C -25°C to +125°C			
Thermal Cycling Overload	-25°C/30 min., Room Temperature/5 min., 125°C/30 min., 5 cycles Rated Voltage x 2.5, 5 sec.	±0.05% ±0.05%	±0.01% ±0.01%	±0.01% ±0.0025%	±0.005% ±0.001%
Solderability	235°C, 2 sec.	over 75% coverage		over 75% coverage	
Resistance to Solvents	Isopropyl Alcohol	no damage		no damage	
Low Temperature Operation Terminal Strength	-25°C, No Load, 2 hrs. 0.908 kg (2 pounds), 10 sec.	±0.05% ±0.05%	±0.01% ±0.01%	±0.0025% ±0.0025%	±0.001% ±0.001%
Dielectric Withstanding Voltage Insulation Resistance	Atmo. Pres.: AC 300V, 1 min. DC 100V, 1 min.	±0.03%	±0.01%	±0.0025%	±0.001%
Resistance to Soldering Heat Moisture Resistance	350°C, 3 sec. +65°C to -10°C, 90% RH to 98% RH, Rated Voltage, 10 cycles (240 hrs.)	over 10,000 M Ω		over 10,000 M Ω	
Shock Vibration	50G, 11 ms, Half-Sine Wave, X, Y, Z, each 3 shocks 20G, 10 Hz to 55 Hz to 10 Hz, 1 min., X, Y, Z, each 2 hrs.	±0.03% ±0.03%	±0.01% ±0.01%	±0.005% ±0.005%	±0.001% ±0.001%
Life (Rated Load)	70°C, Rated Power, 1.5 hr. – ON, 0.5 hr. – OFF, 1,000 hrs.	±0.1%	±0.05%	±0.01%	±0.005%
Life (Moisture Load)	40°C 90% RH to 95% RH, Rated Power 1.5 hrs – ON, 0.5 hr. – OFF, 1,000 hrs.	±0.05%	±0.01%	±0.01%	±0.005%
Storage Life	15°C to 35°C, 15% RH to 75% RH, No Load, 10,000 hrs	±0.02%	±0.01%	±0.005%	±0.0025%
High Temperature Exposure	125°C, No Load, 1,000 hrs.	±0.05%	±0.01%	±0.01%	±0.005%

EXAMPLE OF APPLICATION

An application of type SM/SLD (input/feedback resistors for amplifiers) Because the input and the feedback resistors are incorporated into one single element, amplification is not affected by temperature range.

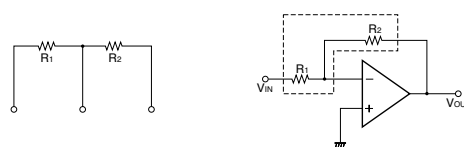

High Power Precision Shunt Resistor, Up to 500W

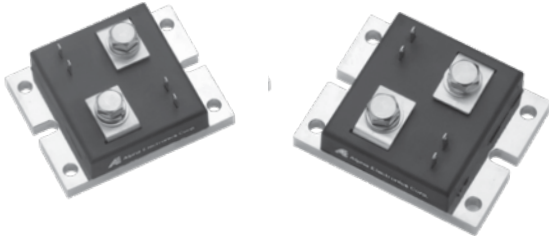

RoHS
COMPLIANT



FEATURES

- Temperature coefficient of resistance (TCR)
 - +25°C to +60°C, +25°C ref.: 0 ±1 ppm/°C
 - 25°C to +125°C, +25°C ref.: 0 ±5 ppm/°C
- Utilizing Ni-Cr Bulk Metal® Foil Technology for realizing low TCR
- Low thermal resistance with Copper plate
 - Improved to 0.1°C/W from 0.3°C/W (conventional model)
 - Maximum rated power up to 500W on heat sink
- Extended max. ambient temperature to 125°C (85°C with conventional model)
- Built-in Pt100 sensor monitor temperature of resistive element
 - Easily define size of suitable heat sink
 - As safety function for continuous operation

CONSTRUCTION OF MATERIALS

- Base plate: Nickel-plated Copper
- Current terminal: Nickel-plated Copper (T = 1.0 mm)
- Voltage and Pt terminals: Nickel-plated Copper (T = 0.5 mm)
- Package: PPS Injection-molded case

APPLICATIONS

- Output reference of precision power supply
- Reference of charge-discharge test for high capacity batteries

COMPOSITION OF TYPE NUMBER

Example:

FNP Z R0100 B

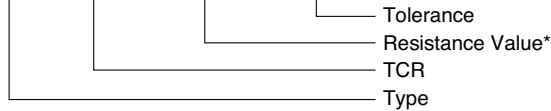

* R is a dual-purpose letter that designates both the value range (R for ohmic) and the location of decimal point.

TCR – RESISTANCE VS. TOLERANCE

Tolerance of Built-in Pt100 Sensor:
±[0.8 + 0.008(t)]°C

TCR (ppm/°C)	Resistance Range (Ω)	Tolerance (%)	Rated Power (W)
0 ±1 (Z) 0 ±2.5 (Y) (+25°C to +60°C)	0.001 to 10**	±0.05 (A) ±0.1 (B) ±0.5 (D) ±1.0 (F)	500 (on heat sink*)
0 ±5 (X) (-25°C to +125°C)			

* Keep temperature of element surface less than 125°C.

** Please contact us for higher resistance value

CONFIGURATION – Dimensions in mm

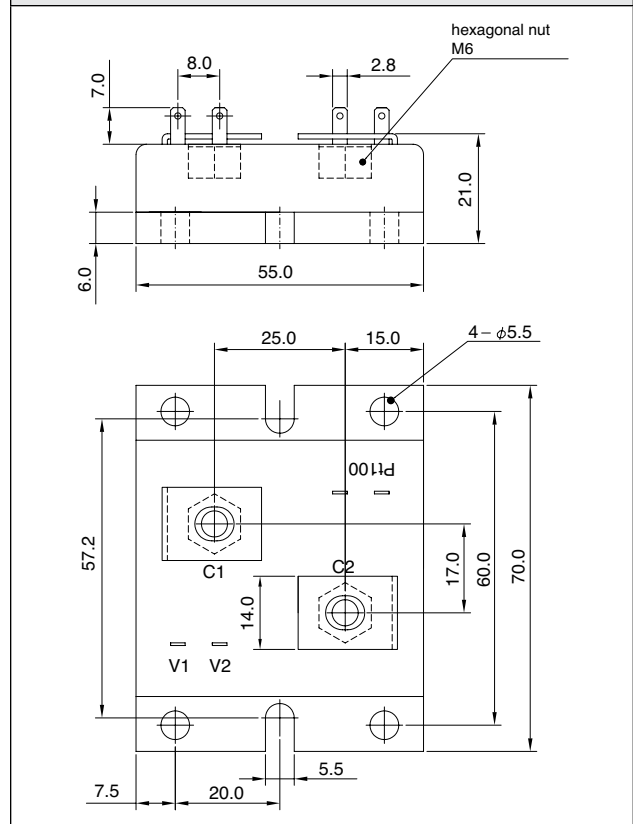

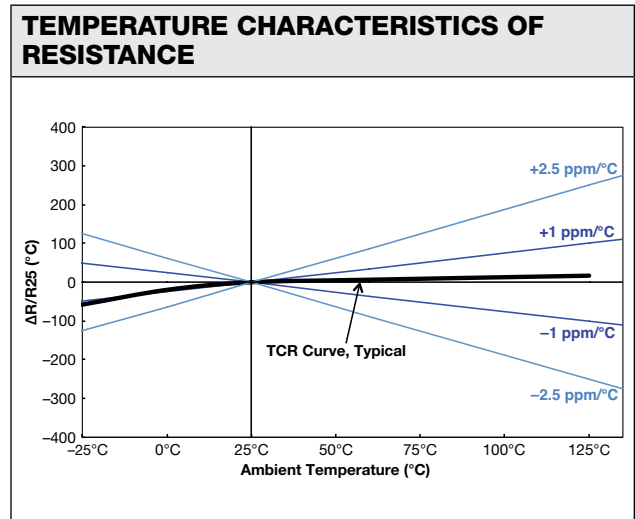
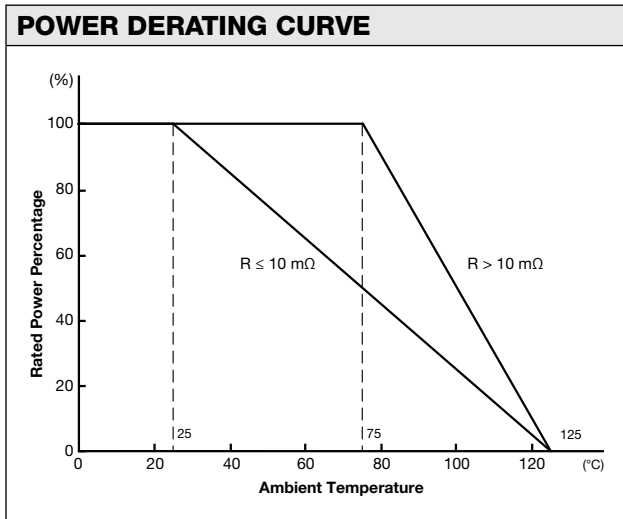
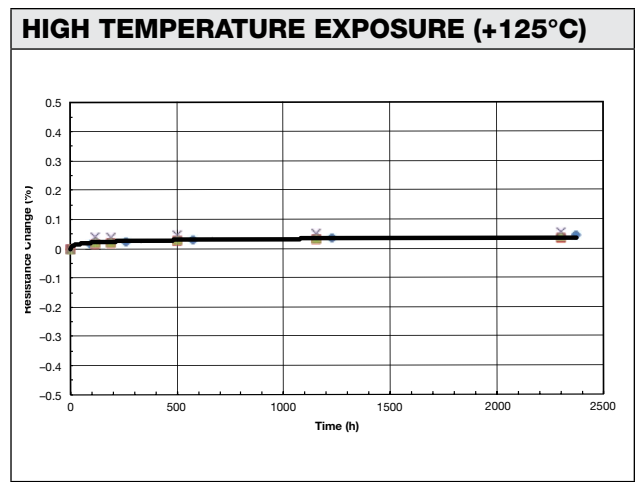
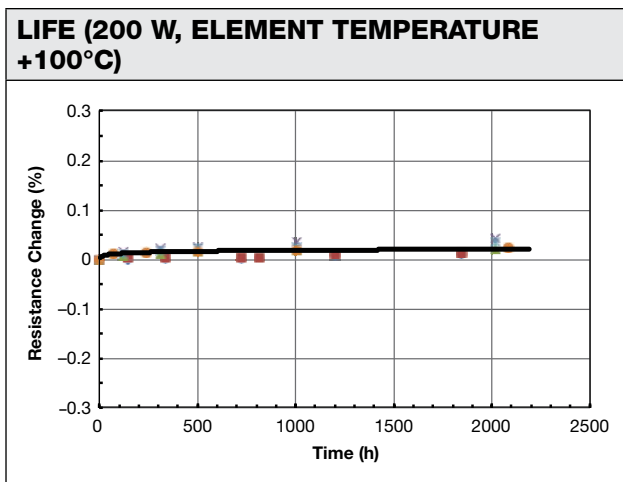
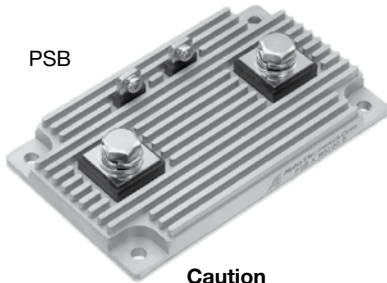

TABLE 2 – PERFORMANCE	
PARAMETERS	SPECIFICATION
Maximum Rated Operating Temperature	25°C (R ≤ 10 mΩ) 75°C (R > 10 mΩ)
Working Temperature Range	-55°C to +125°C
Maximum Working Current	320 A
Single Pulse Power Load	50 J (tp < 10 msec)
Dielectric Withstanding Voltage	AC 500 V
Inductance	< 10 nH
Internal Thermal Resistance (element/base plate)	$R_{\theta} < 0.1^{\circ}\text{C}/\text{W}$ (R > 10 mΩ) $R_{\theta} < 0.2^{\circ}\text{C}/\text{W}$ (R ≤ 10 mΩ)
Life (200 W, Element Temperature 100°C)	±0.2% (2000 h)
High Temperature Exposure (125°C)	±0.2% (2000 h)



Ultra Precision Shunt Resistor (40 Watts)



PSB



RoHS
COMPLIANT

Caution
Please screw current terminals
<5N · m, voltage terminal <1N · m

COMPOSITION OF TYPE NUMBER

Example:

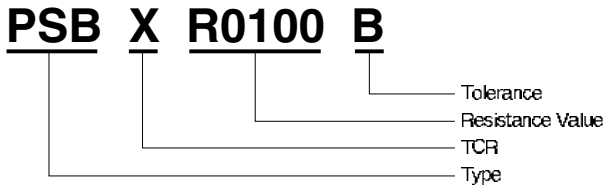

Resistance value in ohm is expressed by a series of four significant digits and an R designating the decimal point.

CONFIGURATION (DIMENSIONS IN mm)

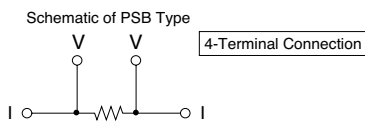
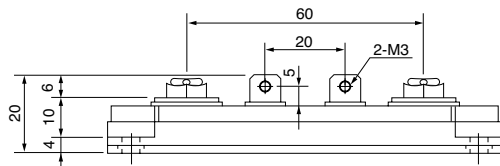
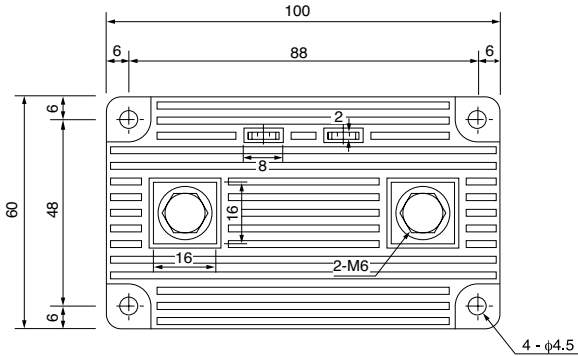

Weight = 170g

FEATURES

- Excellent temperature characteristics created by Bulk Metal® foil technology
- Accurate value on four-terminal wiring, even in low extremity of resistance
- High heat dissipation due to aluminum-clad construction with fins
- Readiness to mount to heat sink or water-cooled radiator
- Availability of threaded holes to fix cables with screw

APPLICATIONS

- Current-sensing in precise power supply, motor driver, etc.

TCR, RESISTANCE RANGE, TOLERANCE, RATED POWER

TCR (ppm/°C) 0°C to +60°C	Resistance Range (Ω)	Resistance Tolerance (%)	Rated Power (W) at 25°C
0±15 (W)	0.001 to 0.005	±0.1 (B) ±0.5 (D) ±1 (F)	12 in free air and 40 On heat sink*
0±5 (X) 0±15 (W)	0.005 to 1		

*Thermal resistance of the heat sink 1°C/W.

Available to use higher rated power with elevation of cooling effect.
Please keep temperature of element surface less than 60°C.

POWER DERATING CURVE

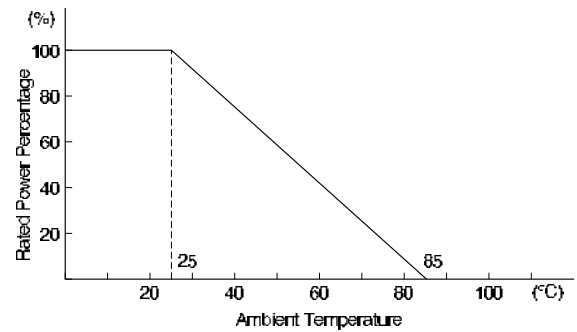

EXAMPLE OF APPLICATIONS

Motor Control Circuit Using Shunt Resistor

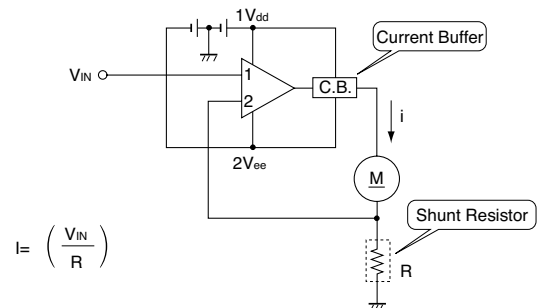

PERFORMANCE			
Parameters	Test Condition	ALPHA Specification	ALPHA Typical Test Data
Maximum Rated Operating Temperature Working Temperature Range Maximum Working Current			25°C -55°C to +85°C 100A
Power Conditioning	25°C, Rated Power, 96 hrs.	±0.1%	±0.05%
Low Temperature Storage and Operation	-55°C, No Load, 24 hrs.	±0.1%	±0.05%
Dielectric Withstanding Voltage Insulation Resistance Low Temperature Operation Overload	Atmo. Pres.: AC 750V, 1 min. DC 500V, 2 min. -55°C, Rated Power Rated Power x 2.5, 5 sec.	±0.05% over 10,000 MΩ ±0.1% ±0.1%	±0.01% over 10,000 MΩ ±0.05% ±0.05%
Moisture Resistance	+65°C to -10°C, 90% RH to 98% RH, Rated Voltage, 10 cycles (240 hrs.)	±0.1%	±0.05%
Shock High Frequency Shock	30G, 11 ms., Half-Sine Wave, X, Y, Z, 10 shocks each 10 Hz to 50 Hz to 10 Hz, 1 min. X, Y, Z, 2.0 hrs. each	±0.05% ±0.05%	±0.1% ±0.1%
Life	25°C, Rated Power, 1.5 hrs. – ON, 0.5 hrs. – OFF, 2,000 hrs.	±0.2%	±0.05%
High Temperature Exposure	85°C, No Load, 2,000 hrs.	±0.2%	±0.05%
Storage Life	15°C to 35°C, 15% RH to 75% RH, No Load, 10,000 hrs.	±0.05%	±0.01%
Internal Thermal Resistance	Between resistive element and base plate		0.3°C/W
Thermal Electromotive Force			1 μV/°C

FREQUENCY CHARACTERISTICS

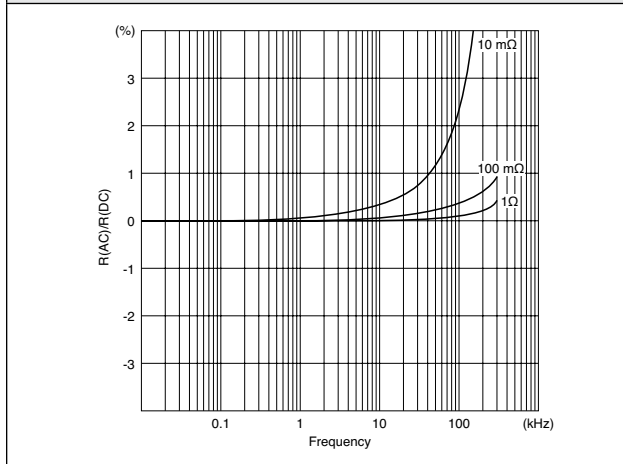

TEMPERATURE OF RESISTOR SURFACE

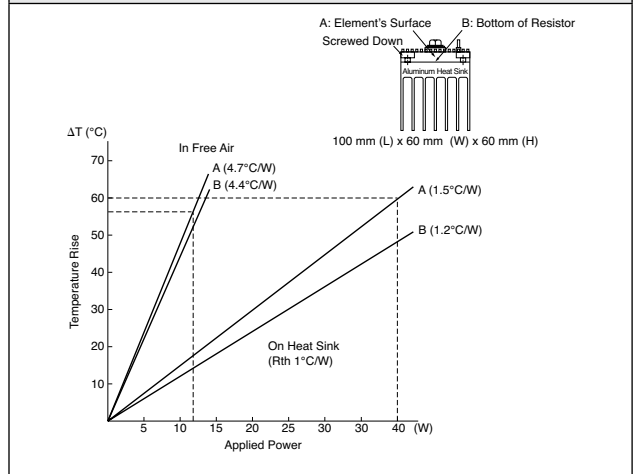

Ultra Precision Power Resistor (10 Watts)

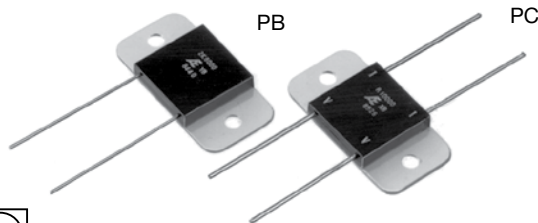

RoHS
COMPLIANT

COMPOSITION OF TYPE NUMBER

Example:

PB X 50R000 B

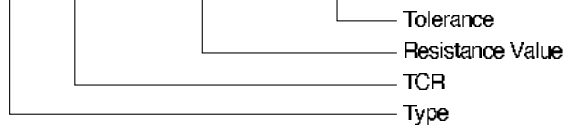

Resistance value, in ohm, is expressed by a series of six characters, five of which represent significant digits. R or K is a dual-purpose letter that designates both the value range (R for ohmic; K for kilo-ohm) and the location of decimal point.

TCR, RESISTANCE RANGE, TOLERANCE, RATED POWER				
Type	TCR (ppm/°C) -25°C to 125°C*	Resistance Range (Ω)	Resistance Tolerance (%)†‡	Rated Power (W) at 25°C
PB	0±15 (W)	0.4 to 1	1 to ±5 (F, G, J)	2 in free air and 10 On heat sink **
	0±15 (W) 0±5 (X) 0±2.5 (Y)	1 to 5	±0.5 to ±5 (D, F, G, J)	
		5 to 10	±0.1 to ±5 (B, D, F, G, J)	
		10 to 25	±0.05 to ±5 (A, B, D, F, G, J)	
		25 to 50	±0.02 to ±5 (Q, A, B, D, F, G, J)	
	50 to 50k	±0.01 to ±5 (T, Q, A, B, D, F, G, J)		
PC	0±15 (W)	0.002 to 0.05	±0.5 to ±5 (D, F, G, J)	
	0±15 (W) 0±5 (X)	0.05 to 0.1	±0.5 to ±5 (D, F, G, J)	
	0±15 (W) 0±5 (X) 0±2.5 (Y)	0.1 to 5	±0.1 to ±5 (B, D, F, G, J)	
		5 to 10	±0.05 to ±5 (A, B, D, F, G, J)	
		10 to 25	±0.02 to ±5 (Q, A, B, D, F, G, J)	
	25 to 100	±0.01 to ±5 (T, Q, A, B, D, F, G, J)		

* Symbols in parentheses are for type number composition.

† Resistance figures for type PB are the values obtained by measuring the leads at point 12.7±3.2 mm away from the root, but in case of resistance below 10 ohm, the values at 5.08±0.6 mm away.

** For heat sinking, an aluminum chassis in 152.4 (L) x 101.6 (W) x 50.8 (H) x 1.0 mm (T) shall be used.

CONFIGURATION (DIMENSIONS IN mm)

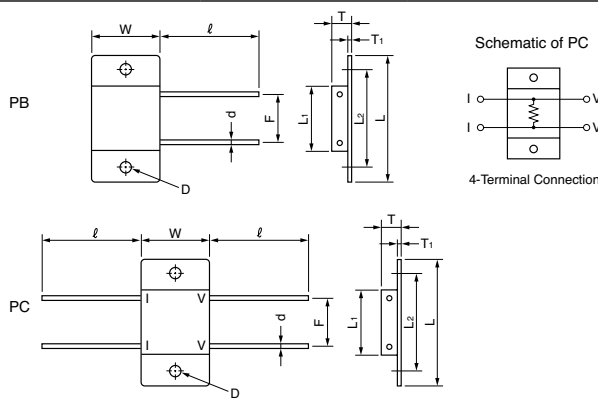

Type	PB	PC
L	40.0±0.2	
L1	20.0±0.2	
L2	30.0±0.5	
W	20.0±0.2	
T	5.0±0.2	
T1	1.0±0.1	
F	15.0±0.5	
ℓ	30±10	
D	Dia. 4.0	
d	Dia. 0.8±0.05	Dia. 1.2±0.05

POWER DERATING CURVE

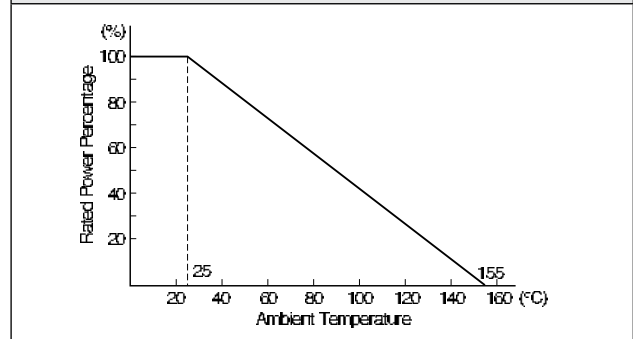

PERFORMANCE			
Parameters	Test Condition	MIL-R-39009 Specification	ALPHA Typical Test Data
Maximum Rated Operating Temperature Working Temperature Range Maximum Working Voltage Maximum Working Current		25°C -55°C to +155°C 750V PB=5A, PC=32A	
Power Conditioning	25°C, Rated Voltage, 96 hrs.	±0.2%	±0.2%
Low Temperature Storage Dielectric Withstanding Voltage Insulation Resistance Low Temperature Operation Overload Moisture Resistance Terminal Strength	-55°C, No Load, 24 hrs. Atmo. Pres.: AC 1 KV, 1 min. Baro. Pres. 8 mHg: AC 500V, 1min. DC 500V, 2 min. -55°C, Rated Voltage Rated Voltage x 2.5, 5 sec. +65°C to -10°C, 90% RH to 98% RH, Rated Voltage, 10 cycles (240 hrs.) 2.27 kg (5 pounds), 10 sec.	±0.3% ±0.2% over 10,000 MΩ ±0.3% ±0.3% ±0.5% ±0.2%	±0.005% ±0.005% over 10,000 MΩ ±0.005% ±0.01% ±0.05% ±0.005%
Shock Vibration, High Frequency	100G, 6 ms., Sawtooth Wave, X, Y, Z, each 3 shocks 20G, 10 Hz to 2,000 Hz to 10 Hz, 20 min., X, Y, Z, each 4 hrs.	±0.2% ±0.2%	±0.005% ±0.005%
Life	25°C, Rated Power, 1.5 hr. - ON, 0.5 hr. - OFF, 2,000 hrs.	±1.0%	±0.01%
High Temperature Exposure	155°C, No Load, 2,000 hrs.	±1.0%	±0.01%
Solderability	245°C, 5 sec.	over 95% coverage	

FREQUENCY CHARACTERISTICS

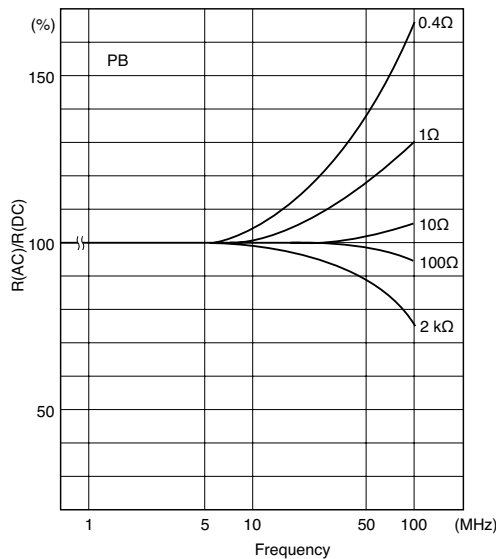

TEMPERATURE OF RESISTOR SURFACE

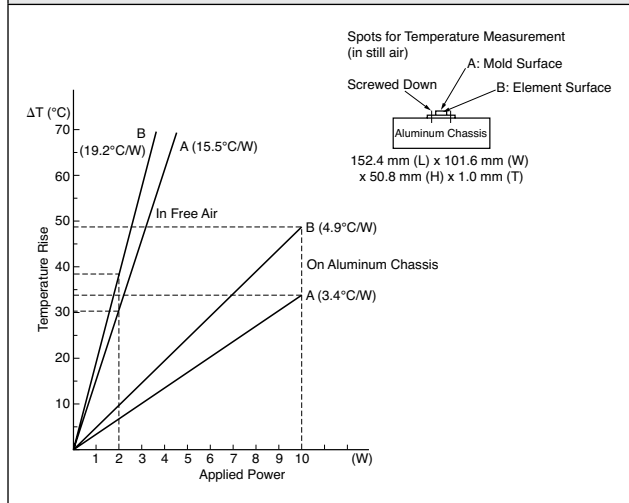

FOUR-TERMINAL RESISTOR

For low ohmic resistor (less than 10 ohm), the resistance value and TCR of the copper lead increases overall resistance value. Four-terminal (Kelvin) connection is recommended per the following figure. Loading current at terminals (V) causes measurement error.

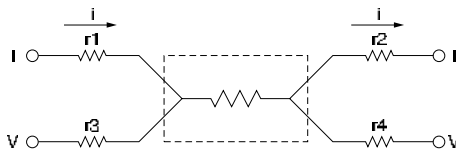

AFFECT OF PB TYPE LEAD FOR RESISTANCE VALUE AND TCR

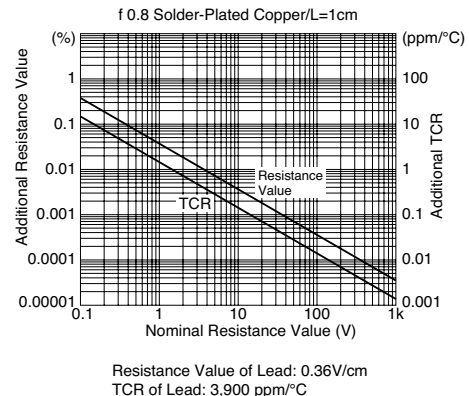

Ultra Precision Shunt Resistor (10 Watts, TO Package)

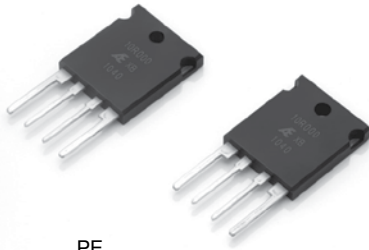

RoHS
COMPLIANT

PE

TCR, RESISTANCE RANGE, TOLERANCE, RATED POWER			
TCR (ppm/°C) -25°C to +125°C	Resistance Range (Ω)	Resistance Tolerance (%)	Rated Power (W) at 70°C
0±15 (W) 0±5 (X)	0.5 to 1	±0.05 to ±5 (A, B, D, F, G, J)	1.5 in free air and 10 on heat sink**
	1 to 5	±0.02 to ±5 (Q, A, B, D, F, G, J)	
0±15 (W) 0±5 (X) 0±2.5 (Y)	5 to 25	±0.02 to ±5 (Q, A, B, D, F, G, J)	
	25 to 500	±0.01 (T), ±0.02 (Q) ±0.05 (A), ±0.1 (B) ±0.5 (D), ±1 (F) ±2 (G), ±5 (J)	

** For heat sinking, an aluminum chassis in 152.4 mm (L) × 101.6 mm (W) × 50.8 mm (H) × 1.0 (T) shall be used.

COMPOSITION OF TYPE NUMBER

Example:

PE X 1R0000 B

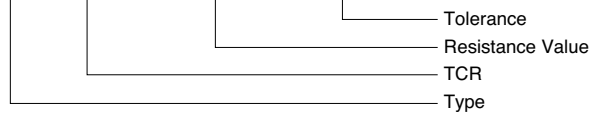

Resistance value, in ohms, is expressed by a series of six characters, five of which represent significant digits. R or K is a dual-purpose letter that designates both the value range (R for ohmic; K for kilo-ohm) and the location of the decimal point.

POWER DERATING CURVE

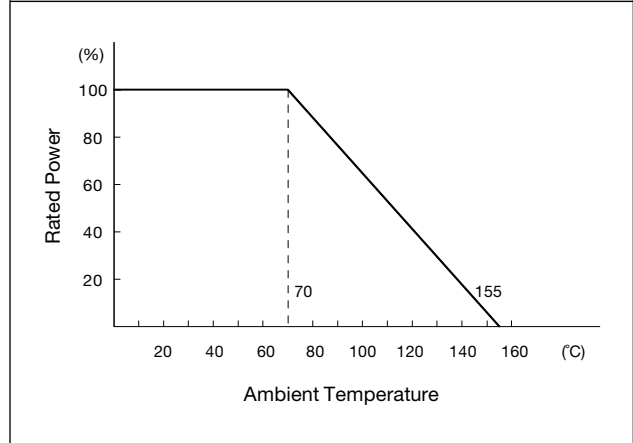

CONFIGURATION (DIMENSIONS IN mm)

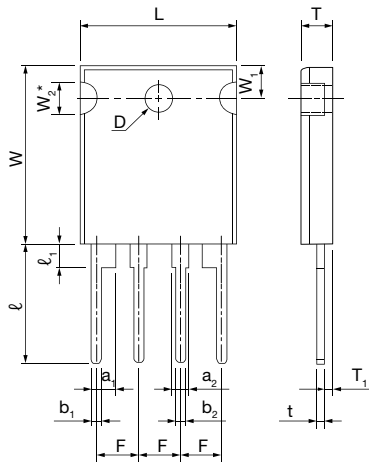

Type	PE
L	19.0±0.5
W	22.0±0.5
W ₁	4.0±0.2
W ₂ *	4.0±0.2
T	4.0±0.2
T ₁	1.3±0.2
F	5.08±0.5
l	15.0±1
l ₁	3.0±0.2
t	0.8±0.1
a ₁	3.0±0.2
a ₂	2.0±0.2
b ₁	1.4±0.1
b ₂	1.0±0.1
D	Dia. 3.4±0.2

*half circle recess in molding (2)

Schematic of PE

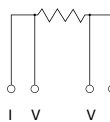

FREQUENCY CHARACTERISTICS

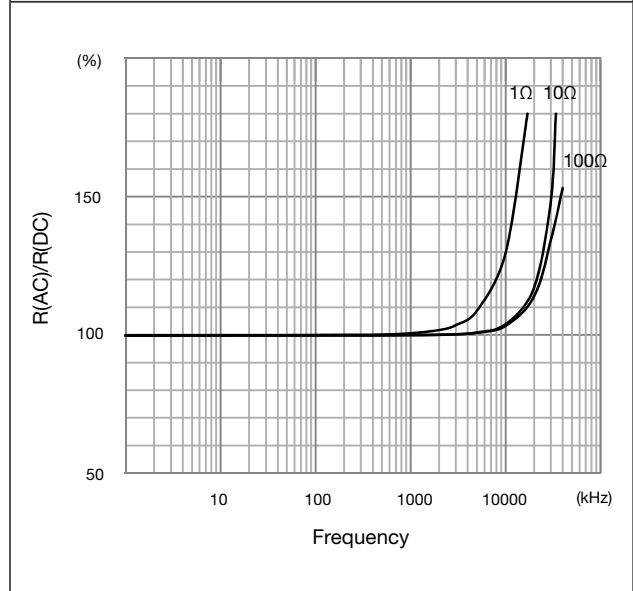

PERFORMANCE			
Parameters	Test Condition	ALPHA Specification	ALPHA Typical Test Data
Maximum Rated Operating Temperature Working Temperature Range Maximum Working Current		70°C -55°C to +155°C 5A	
Power Conditioning	25°C, Rated Power, 96 hrs.	±0.05%	±0.01%
Low Temperature Storage Dielectric Withstanding Voltage Insulation Resistance Low Temperature Operation Overload Moisture Resistance Terminal Strength	-55°C, No Load, 24 hrs. Atmo. Pres.: AC 1 KV, 1 min. Baro. Pres. 8 mHg: AC 500V, 1 min. DC 500V, 2 min. -55°C, Rated Power Rated Power x 2.5, 5 sec. +65°C to -10°C, 90% RH to 98% RH, Rated Voltage, 10 cycles (240 hrs.) 2.27 kg (5 pounds), 10 sec.	±0.01% ±0.01% over 10,000 MΩ ±0.01% ±0.05% ±0.05% ±0.05%	±0.005% ±0.005% over 10,000 MΩ ±0.005% ±0.01% ±0.02% ±0.005%
Shock Vibration, High Frequency	100G, 6 ms., Sawtooth Wave, X, Y, Z, each 3 shocks 20G, 10 Hz to 2,000 Hz to 10 Hz, 20 min., X, Y, Z, each 4 hrs.	±0.01% ±0.01%	±0.005% ±0.005%
Life	70°C, Rated Power, 1.5 hr. – ON, 0.5 hr. – OFF, 2,000 hrs.	±0.05%	±0.02%
High Temperature Exposure	155°C, No Load, 2,000 hrs.	±0.05%	±0.02%
Solderability	245°C, 5 sec.	over 95% coverage	

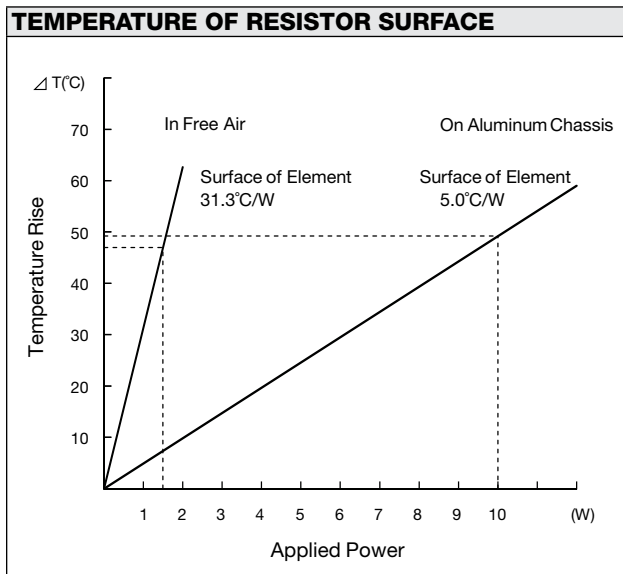

Ultra Precision Power Resistor (8 Watts, TO-220)

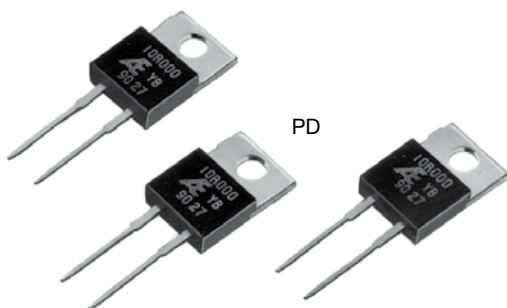

COMPOSITION OF TYPE NUMBER

Example:

PD X 50R000 B

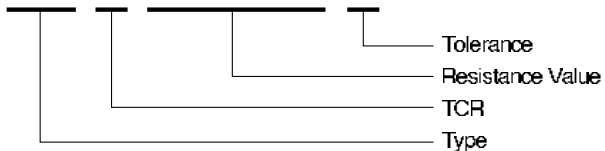

Resistance value, in ohm, is expressed by a series of six characters, five of which represent significant digits. R or K is a dual-purpose letter that designates both the value range (R for ohmic; K for kilo-ohm) and the location of decimal point.

CONFIGURATION (DIMENSIONS IN mm)

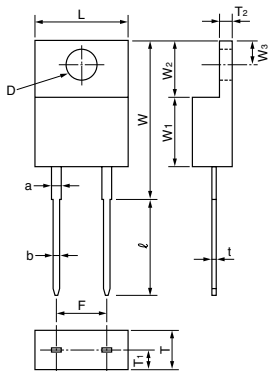

Type	PD
L	10.6 max.
W	19.0±0.5
W ₁	8.5±0.2
W ₂	6.5±0.2
W ₃	2.7±0.5
T	4.5±0.2
T ₁	2.0±0.5
T ₂	1.5±0.2
F	5.08±0.5
l	11.0±2
t	0.5±0.05
a	1.2±0.1
b	0.75±0.05
D	Dia. 3.6

TCR, RESISTANCE RANGE, TOLERANCE, RATED POWER

Type	TCR (ppm/°C) -25°C to +125°C*	Resistance Range (Ω)	Resistance Tolerance (%)†	Rated Power (W) at 25°C
PD	0±15 (W)	0.1 to 1	±1 to ±5 (F, G, J)	1.5 In free air
		1 to 5	±0.5 to ±5 (D, F, G, J)	
	0±5 (X) 0±2.5 (Y)	5 to 10	±0.1 to ±5 (B, D, F, G, J)	8 On heat sink**
		10 to 25	±0.05 to ±5 (A, B, D, F, G, J)	
		25 to 10k	±0.02 to ±5 (Q, A, B, D, F, G, J)	

* Symbols in parentheses are for type number composition.

† Resistance figures are the values obtained by measuring the leads at point 5.08±0.6 mm away from the root.

** For heat sinking, an aluminum chassis in 152.4 (L) x 101.6 (W) x 50.8 (H) x 1.0 mm (T) should be used.

POWER DERATING CURVE

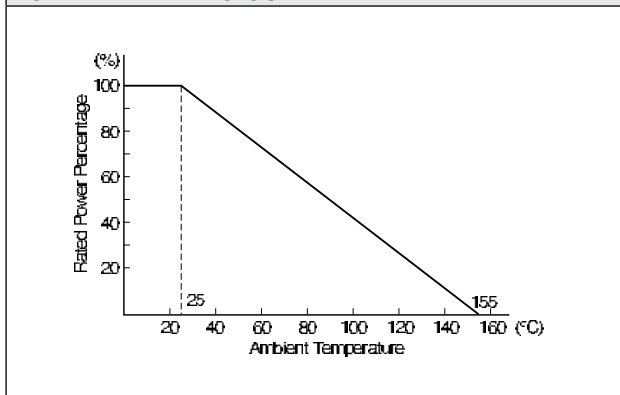

PERFORMANCE			
Parameters	Test Condition	MIL-R-39009 Specification	ALPHA Typical Test Data
Maximum Rated Operating Temperature Working Temperature Range Maximum Working Voltage Maximum Working Current			25°C -55°C to +155°C 250V 4A
Power Conditioning	25°C, Rated Voltage, 96 hrs.	±0.2%	±0.02%
Low Temperature Storage Dielectric Withstanding Voltage Insulation Resistance Low Temperature Operation Overload	-55°C, No Load, 24 hrs. Atmo. Pres.: AC 1 kV, 1 min. Baro. Pres. 8 mHg: AC 500V, 1min. DC 500V, 2 min. -55°C, Rated Voltage Rated Voltage x 2.5, 5 sec.	±0.3% ±0.2% over 10,000 MΩ ±0.3%	±0.005% ±0.005% over 10,000 MΩ ±0.005%
Moisture Resistance Terminal Strength	+65°C to -10°C, 90% RH to 98% RH, Rated Voltage, 10 cycles (240 hrs.) 0.908 kg (2 pounds), 10 sec.	±0.3% ±0.5% ±0.2%	±0.01% ±0.05% ±0.005%
Shock Vibration, High Frequency	100G, 6 ms, Sawtooth Wave, X, Y, Z, each 3 shocks 20G, 10 Hz to 2,000 Hz to 10 Hz, 20min., X, Y, Z, each 4 hrs.	±0.2% ±0.2%	±0.005% ±0.005%
Life	25°C, Rated Power, 1.5 hr. – ON, 0.5 hr. – OFF, 2,000 hrs.	±1.0%	±0.01%
High Temperature Exposure	155°C, No Load, 2,000 hrs.	±1.0%	±0.01%
Solderability	245°C, 5 sec.	over 95% coverage	

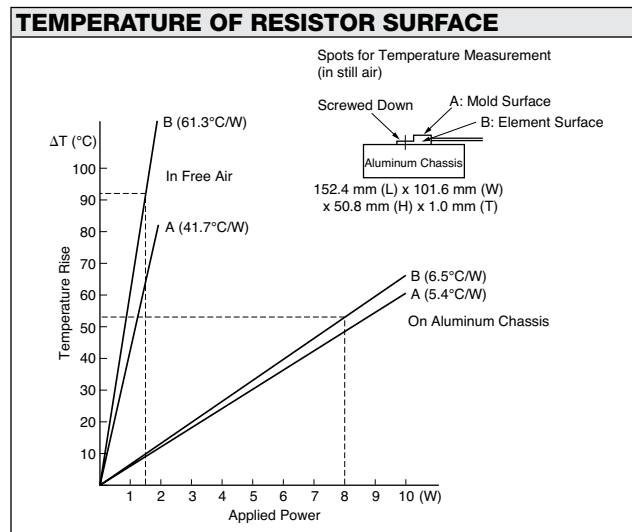
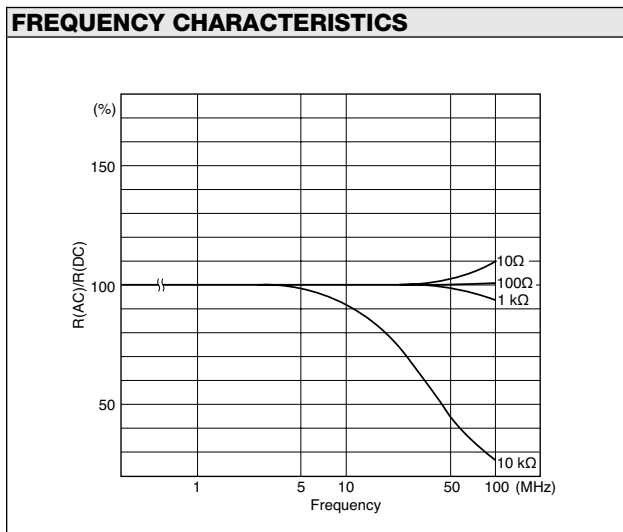

Ultra Precision Resistor (Hermetically Sealed)

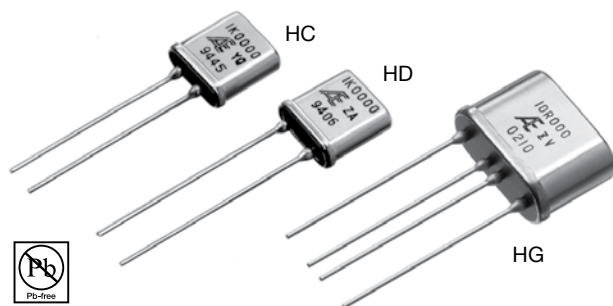

RoHS
COMPLIANT

COMPOSITION OF TYPE NUMBER

Example:

HC Y 30K000 T

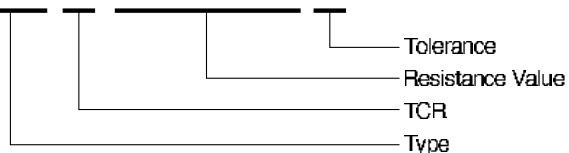

Resistance value, in ohm, is expressed by a series of six characters, five of which represent significant digits. The sixth R or K is a dual-purpose letter that designates both the value range (R for ohmic; K for kilo-ohm) and the location of decimal point.

CONFIGURATION (DIMENSIONS IN mm)

HC, HD Type

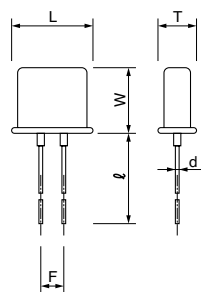

HG Type

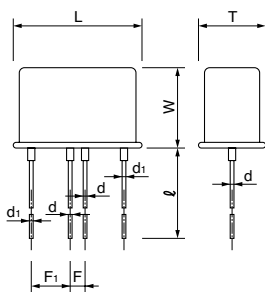

Type	HC	HD	HG
L	10.7±0.3		19.0±0.3
W	10.7±0.3		12.8±0.3
T	4.3±0.3		8.8±0.3
F	3.81±0.25	5.08±0.25	2.54±0.25
F1	-		5.08±0.25
l	30±10		
d	Dia. 0.65±0.05		
d1	Dia. 0.8±0.05		

TCR, RESISTANCE RANGE, TOLERANCE, RATED POWER

Type	TCR (ppm/°C) -55°C to +125°C*	Resistance Range (Ω)	Resistance Tolerance (%)†‡	Rated Power (W) at 125°C
HC HD	0±15 (W)	1 to 5	±0.5 (D) ±1 (F)	0.3
	0±5 (X)	5 to 30	±0.1 (B) ±0.5 (D) ±1 (F)	
	0±5 (X) 0±2.5 (Y) 0±1 (Z)**	30 to 120k	±0.005 (V) ±0.01 (T) ±0.02 (Q) ±0.05 (A) ±0.1 (B) ±0.5 (D) ±1 (F)	
HG	0±2.5 (Y) 0±1 (Z)**	1 to 10	±0.01 (T) ±0.02 (Q) ±0.05 (A) ±0.1 (B) ±0.5 (D) ±1 (F)	
		10 to 10k	±0.005 (V) ±0.01 (T) ±0.02 (Q) ±0.05 (A) ±0.1 (B) ±0.5 (D) ±1 (F)	

* Symbols in parentheses are for type number composition.

† Resistance figures are obtained by measuring the leads at point 12.7±3.2 mm away from the base for type HC and HD, but, in case of resistance below 10 ohm, the value at 1.6±0.6 mm away from the base for all types.

**Temperature characteristic Z is applicable for temperature range between 0°C and 60°C.

POWER DERATING CURVE

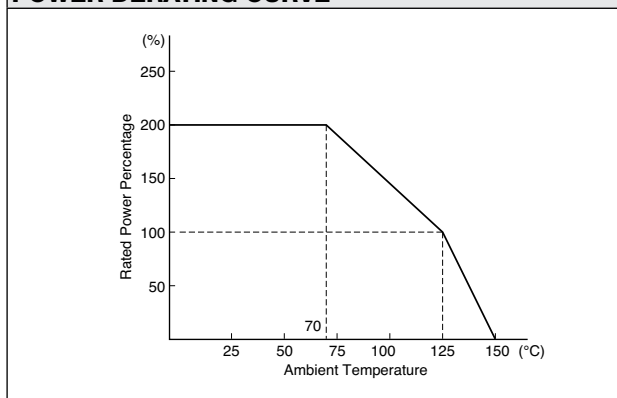

FOUR-TERMINAL (KELVIN) CONNECTION

For low ohmic resistor (less than 10 ohm), the resistance value and TCR of the copper lead increases overall resistance value. Four-terminal (Kelvin) connection is recommended per the following figure. Loading current at voltage and current terminals (V, I) causes measurement error.

Four-Terminal Resistor

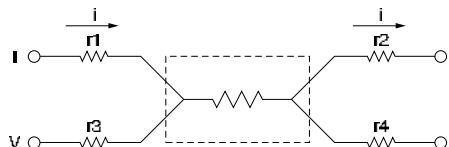

PERFORMANCE			
Parameters	Test Condition	MIL-PRF-55182/9 Specification	ALPHA Typical Test Data
Maximum Rated Operating Temperature Working Temperature Range Maximum Working Voltage		125°C -65°C to +150°C 300V	
Power Conditioning Thermal Shock Overload	125°C, Rated Power, 100 hrs. -65°C/30 min. ↔ +150°C/30 min., 5 cycles Rated Voltage x 6.25, 5 sec.	±(0.20% +0.01%) ±0.05% ±0.05%	±0.0025% ±0.0025% ±0.0025%
Solderability	Steam Aging 8 hrs., 245°C, 5 sec.	over 95% coverage	
Resistance to Solvents	① Isopropyl Alcohol + Mineral Spirits ② Water + Butyl Cellosolve + Monoethanolamine	no damage	
Low Temperature Storage Low Temperature Operation Terminal Strength	-65°C, 24 hrs. -65°C Rated Voltage, 45 min. 0.908 kg (2 pounds), 10 sec.	±0.05% ±0.05% ±0.02%	±0.0025% ±0.0025% ±0.001%
Dielectric Withstanding Voltage Insulation Resistance Resistance to Soldering Heat Moisture Resistance	Atom. Pres.: 300V rms. Baro. Pres. 8 mHg: 200V rms. DC 100V, 2 min. 260°C, 10 sec. ±2 sec. +65°C to -10°C, 90% RH to 98% RH, Rated Voltage, 10 cycles (240 hrs.)	±0.02% over 10,000 MΩ ±0.02% ±0.05%	±0.0025% over 10,000 MΩ ±0.0025% ±0.0025%
Shock (Specified Pulse) Vibration, High Frequency	100G, 6 ms, Sawtooth Wave, X, Y, Z, each 10 shocks 20G, 10 Hz to 2,000 Hz to 10 Hz, 20 min., X, Y, each 4 hrs.	±0.01% ±0.02%	±0.0025% ±0.0025%
Life	125°C, Rated Power, 1.5 hr. – ON, 0.5 hr. – OFF, 2,000 hrs.	±0.05%	±0.01%
70°C Power Rating	70°C, Rated Voltage x 2, 1.5 hrs. – ON, 0.5 hr. – OFF, 2,000 hrs.	±0.05%	±0.01%
Storage Life	15°C to 35°C, 15% RH to 75% RH, No Load, 10,000 hrs.	±0.005%	±0.0005%
High Temperature Exposure	175°C, No Load, 2,000 hrs.	±0.5%	±0.01%
Current Noise Voltage Coefficient Thermal EMF		-32 dB 0.0001%/V 1.0 μV/°C	-42 dB 0.00003%/V 0.1 μV/°C

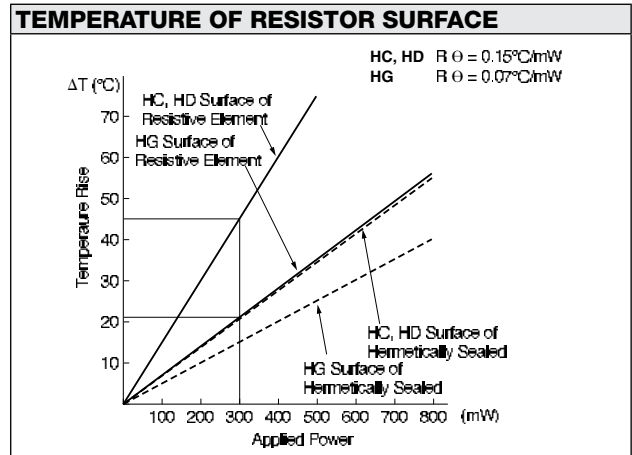
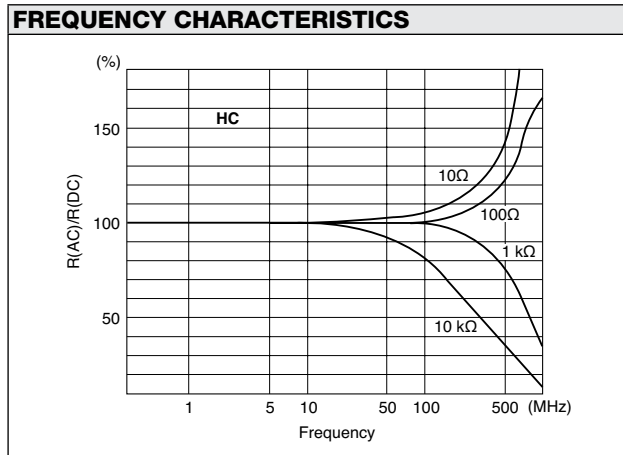

PRECAUTION IN USING HC, HD OR HG RESISTORS

When soldering to mount HC, HD or HG on a board, keep the resistor over 10 mm away from the board surface by using an insulating tube.

Zero-TCR Ultra Precision Resistor (Hermetically Sealed)

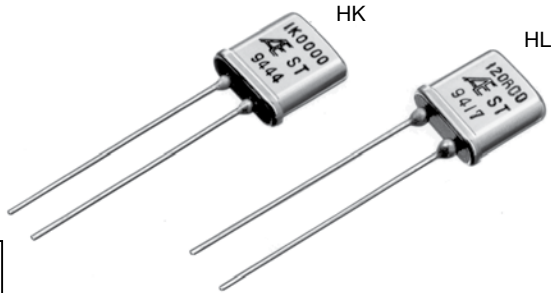

RoHS
COMPLIANT

TCR, RESISTANCE RANGE, TOLERANCE, RATED POWER				
Type	TCR	Resistance Range (Ω)	Resistance Tolerance (%) ^{*†}	Rated Power (W) at 70°C
HK HL	Char. S	100 to 100k	±0.005 (V) ±0.01 (T) ±0.02 (Q) ±0.05 (A) ±0.1 (B) ±0.5 (D) ±1 (F)	0.3

* Symbols parenthesized are for type number composition.
† Resistance figures are obtained by measuring the leads at point 12.7±3.2 mm away from the root.

COMPOSITION OF TYPE NUMBER

Example:
HK S 10K000 T

Resistance value, in ohm, is expressed by a series of six characters, five of which represent significant digits. R or K is a dual-purpose letter that designates both the value range (R for ohmic; K for kilo-ohm) and the location of decimal point.

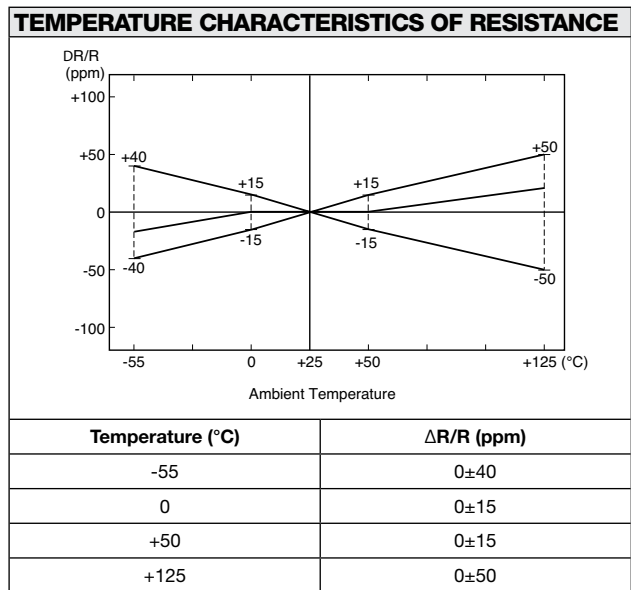

CONFIGURATION (DIMENSIONS IN mm)

HK, HL

Type	HK	HL
L	10.7±0.3	
W	10.7±0.3	
T	4.3±0.3	
F	3.81±0.25	5.08±0.25
l	30±10	
d	φ0.65±0.05	

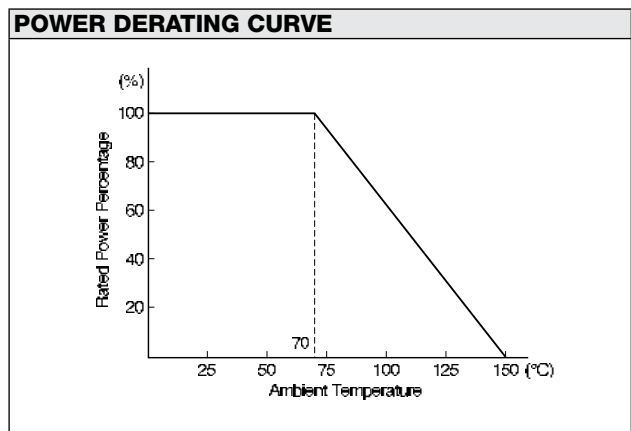

PERFORMANCE			
Parameters	Test Condition	ALPHA Specification	ALPHA Typical Test Data
Maximum Rated Operating Temperature Working Temperature Range Maximum Working Voltage		70°C -65°C to +150°C 300V	
Power Conditioning Thermal Shock Overload	25°C, Rated Voltage, 96 hrs. -65°C/30 min. ↔ +150°C/30 min., 5 cycles Rated Voltage x 2.5, 5 sec.	±0.05%	±0.0025%
Solderability	245°C, 5 sec.	over 95% coverage	over 95% coverage
Resistance to Solvents	① Isopropyl Alcohol + Mineral Spirits ② Water + Butyl Cellosolve + Monoethanolamine	no damage	no damage
Low Temperature Storage Terminal Strength	-65°C, No Load, 24 hrs. → Rated Voltage, 45 min. 0.908 kg (2 pounds), 10 sec.	±0.05% ±0.02%	±0.0025% ±0.001%
Dielectric Withstanding Voltage Insulation Resistance Resistance to Soldering Heat Moisture Resistance	Atmo. Pres.: AC 300V, 1 min. Baro. Pres. 8 mHg: AC200V, 1min. DC 500V, 2 min. 350°C, 3 sec. +65°C to -10°C, 90% RH to 98% RH, Rated Voltage, 10 cycles (240 hrs.)	±0.02% over 10,000 MΩ ±0.05% ±0.05%	±0.0025% over 10,000 MΩ ±0.0025% ±0.0025%
Shock Vibration, High Frequency	100G, 6 ms, Sawtooth Wave, X, Y, Z, each 10 shocks 20G, 10 Hz to 2,000 Hz to 10 Hz, 20 min., X, Y, Z, each 2.5 hrs.	±0.01% ±0.02%	±0.0025% ±0.0025%
Life	70°C, Rated Power, 1.5 hr. – ON, 0.5 hr. – OFF, 2,000 hrs.	±0.05%	±0.01%
Storage Life	15°C to 35°C, 15% RH to 75% RH, No Load, 10,000 hrs.	±0.0025%	±0.0005%
High Temperature Exposure	150°C, No Load, 2,000 hrs.	±0.05%	±0.01%
Current Noise Voltage Coefficient Thermal EMF		-32 dB 0.0005%/V 1.0 μV/°C	-42 dB 0.00003%/V 0.1 μV/°C

FREQUENCY CHARACTERISTICS

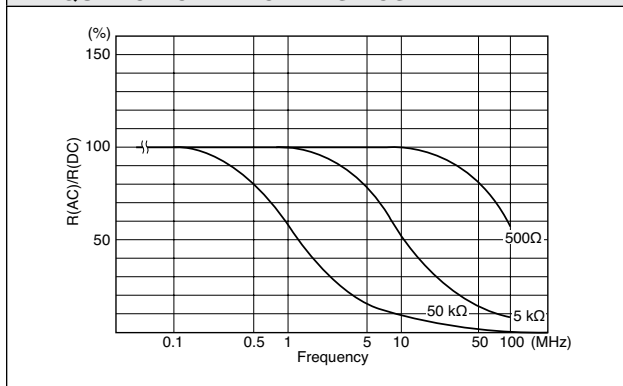

TEMPERATURE OF RESISTOR SURFACE

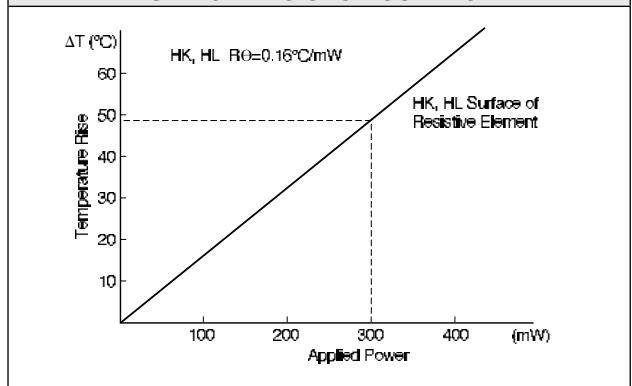

PRECAUTION IN USING HK OR HL RESISTORS

When soldering to mount HK or HL on a board, keep the resistor over 10 mm away from the board surface by using an insulating tube.

Resistor networks from Alpha Electronics, specialists in precision resistors, featuring Bulk Metal® Foil technology, provide excellent performance in TCR tracking, resistance ratio matching and stability.

Characteristics

- Temperature Characteristics of Resistance: 0 ± 5 ppm/°C
- TCR Tracking: ± 1 ppm/°C
- Resistance Ratio Matching: $\pm 0.01\%$
- Resistance Stability: $\pm 0.005\%$ /year

STANDARD CIRCUIT

Circuit A (Array)

Circuit Symbol

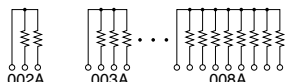

Circuit B (Independent)

Circuit Symbol

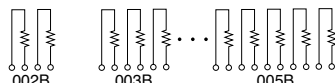

Circuit C (Divider)

Circuit Symbol

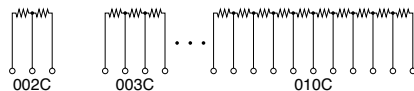

Composition of Circuit Symbol

Example:

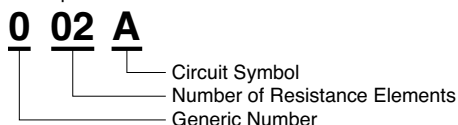

Circuit E (A Circuit Divided into Two)

Circuit Symbol

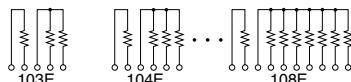

Circuit Symbol

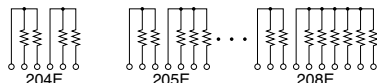

Circuit Symbol

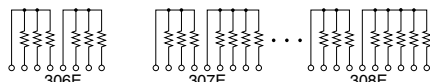

Circuit Symbol

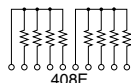

Composition of Circuit Symbol

Example:

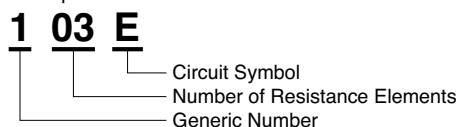

Circuit F (C Circuit Divided into Two)

Circuit Symbol

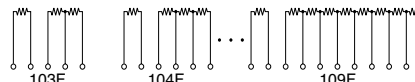

Circuit Symbol

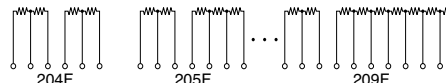

Circuit Symbol

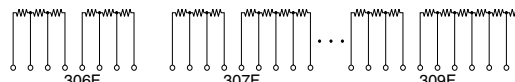

Circuit Symbol

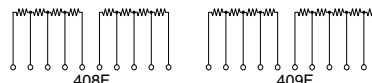

Composition of Circuit Symbol

Example:

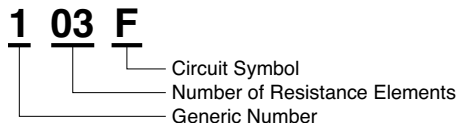

Circuits other than listed are available.

RESISTANCE RANGE AND NUMBER OF ELEMENTS MOUNTABLE

Type	Case Encapsulated Type	Conformally Coated Type			
		SC	SE	SF	SS
Max. Resistance Value/Element (Ω)	120k	120k	120k	20k	
Min. Resistance Value/Element (Ω)	30	30	30	30	
Max. Resistance Value/Package (Ω)	1,200k	600k	240k	100k	
Maximum Number of Network Elements	Circuit A	8	4	—	5
	Circuit B	5	5	2	3
	Circuit C	10	5	2	5
	Circuit E	8	—	—	4
	Circuit F	9	5	—	4

TABLE 1. TEMPERATURE CHARACTERISTICS OF RESISTANCE

TCR (ppm/°C) -25°C to $+125^{\circ}\text{C}$		
Absolute	Tracking	
	Resistance Ratio (R max./R min.)	TCR Tracking Available
0 ± 5	$1 \leq R \text{ max./R min.} \leq 10$	± 1
	$10 < R \text{ max./R min.} \leq 100$	± 2
	$100 < R \text{ max./R min.}$	± 3

Precision Resistor Network (Conformally Coated)

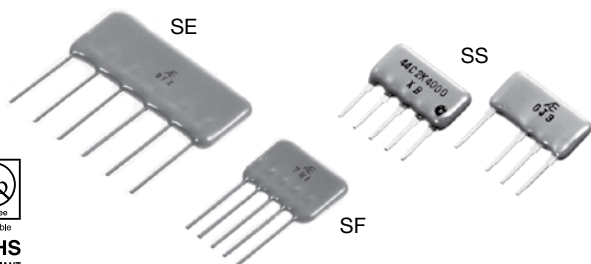

COMPOSITION OF TYPE NUMBER					
Example:					
SE	004A	1K000	/8K000	B	A
①	②	③	④	⑤	⑥
① Type	② Circuit Symbol	③ Resistance Value (R1)	④ Resistance Value (Rn)	⑤ Resistance Tolerance (Absolute)	⑥ Resistance Tolerance (Matching)
Specify all values for R1 to Rn					

CONFIGURATION (DIMENSIONS IN mm)				
	Type	SE	SF	SS
	L	29.0±0.5	14.0±0.5	7.5±0.5 to 15.5±0.5
	W	12.5±0.5	10.0±0.5	7.3±0.5
	T	2.7±0.5		2.2±0.5
	l	5±1		
	t	0.3±0.05		
	a	1.0±0.5		
	b	0.65±0.05		
	c	0.4±0.05		
	F	Multiple of 2.54		

Lead space will be determined depending on circuit and number of elements.

TCR, RESISTANCE RANGE, TOLERANCE, RATED POWER						
Type	TCR (ppm/°C)* -25°C to +125°C	Resistance Range Element (Ω)	Maximum Resistance Value Package (Ω)	Resistance Tolerance (%)**		Rated Power/Package (W) at 70°C
				Absolute	Matching	
SE	0±5	30 to 120k	600k	±0.05 (A)	±0.01 (T) ±0.02 (Q)	1
SF		30 to 120k	240k	±0.1 (B) ±0.5 (D)	±0.05 (A) ±0.1 (B)	0.5
SS		30 to 20k	100k	±1 (F)	±0.5 (D) ±1 (F)	0.5

*TCR tracking is dependent on resistance ratio. See Table 1, Ultra Precision Resistor Network datasheet.
**Symbols parenthesized are for type number composition.

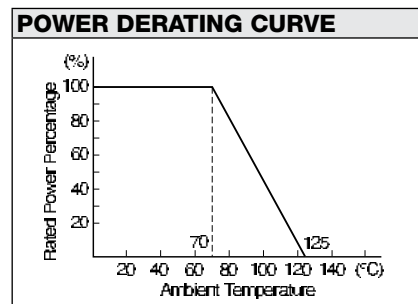

PERFORMANCE					
Parameters	Test Condition	ALPHA Specification		ALPHA Typical Test Data	
		ΔR	ΔRatio	ΔR	ΔRatio
Maximum Rated Operating Temperature Working Temperature Range		70°C -25°C to +125°C			
Temperature Cycling	-25°C/30 min., Room Temperature/5 min., +125°C/30 min., 5 cycles	±0.05%	±0.01%	±0.01%	±0.005%
Low Temperature Storage Overload Terminal Strength	-25°C, No Load, 2 hrs. Rated Voltage x 2.5, 5 sec. 0.51 kg (1.123 pounds), 10 sec.	±0.05%	±0.01%	±0.005%	±0.0025%
Dielectric Withstanding Voltage Insulation Resistance Resistance to Soldering Heat Moisture Resistance	Atmo. Pres.: AC 300V, 1 min. DC 100V, 1 min. 350°C, 3 sec. +65°C to -10°C, 90% RH to 98% RH, Rated Voltage, 10 cycles (240 hrs.)	±0.03%	±0.01%	±0.005%	±0.0025%
Shock Vibration	50G, 11 ms., Half-Sine Wave, X, Y, Z, each 3 shocks 20G, 10 Hz to 55 Hz to 10 Hz, 1 min., X, Y, Z, each 2 hrs.	±0.03%	±0.01%	±0.005%	±0.0025%
Life (Rated Load)	70°C, Rated Power, 1.5 hrs. – ON, 0.5 hr. – OFF, 1,000 hrs.	±0.1%	±0.05%	±0.01%	±0.005%
Life (Moisture Load)	40°C, 90% RH to 95% RH, Rated Power, 1.5 hrs. – ON, 0.5 hr. – OFF, 1,000 hrs.	±0.1%	±0.05%	±0.01%	±0.005%
High Temperature Exposure	125°C, No Load, 1,000 hrs.	±0.1%	±0.05%	±0.01%	±0.005%
Storage Life	15°C to 35°C, 15% RH to 75% RH, No Load, 10,000 hrs.	±0.05%	±0.03%	±0.005%	±0.0025%

Precision Thin Film Resistor (Conformally Coated)

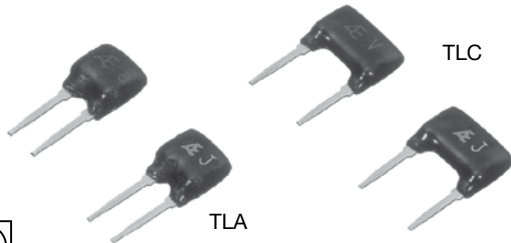

Available
RoHS
COMPLIANT

TCR, RESISTANCE RANGE, TOLERANCE, RATED POWER				
Type	TCR (ppm/°C) -25°C to +125°C*	Resistance Range (Ω)	Resistance Tolerance (%)*	Rated Power (W) at 70°C
TLA	0±10 (C) 0±5 (X)	100K to 5M	±0.05 (A) ±0.1 (B) ±0.5 (D) ±1 (F)	0.125
TLC		200K to 10M	±0.02 (Q) ±0.05 (A) ±0.1 (B) ±0.5 (D) ±1 (F)	0.25

* Symbols in parentheses are for type number composition.

COMPOSITION OF TYPE NUMBER

Example:

TLA X 500K00 B

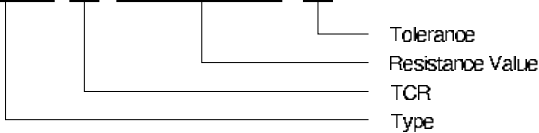

Resistance value, in ohm, is expressed by a series of six characters, five of which represent significant digits. K or M is a dual-purpose letter that designates both the value range (K for kilo-ohm; M for mega-ohm) and the location of decimal point.

POWER DERATING CURVE

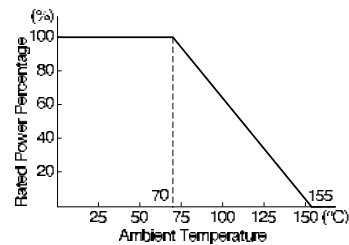

CONFIGURATION (DIMENSIONS IN mm)

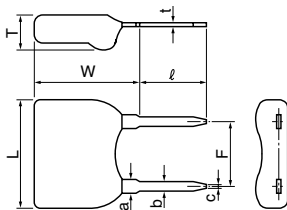

Type	TLA	TLC
L	5.3±0.5	7.3±0.5
W	6.2±0.5	
T	2.2±0.5	
F	2.54±0.25 5.08±0.25	
l	5±1	
t	0.3±0.05	
a	1.0±0.05	
b	0.65±0.05	
c	0.4±0.05	

FREQUENCY CHARACTERISTICS

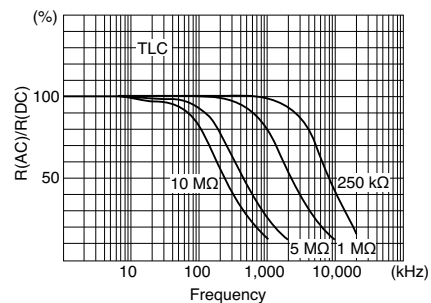

PERFORMANCE

Parameters	Test Condition	ALPHA Specification	ALPHA Typical Test Data
Max. Rated Operating Temperature Working Temperature Range Maximum Working Voltage		70°C -25°C to +155°C TLA = 250V, TLC = 300V	
Temperature Cycling Overload	-25°C/30 min., Room Temperature/5 min., +155°C/30 min., 5 cycles Rated Voltage x 2.5, 5 sec.	±0.05% ±0.05%	±0.01% ±0.0025%
Solderability Resistance to Solvents	235°C, 2 sec. Isopropyl Alcohol	over 75% coverage no damage	
Low Temperature Storage Terminal Strength	-25°C, No Load, 24 hrs. 0.908 kg (2 pounds), 10 sec.	±0.05% ±0.05%	±0.0025% ±0.0025%
Dielectric Withstanding Voltage Insulation Resistance Resistance to Soldering Heat Moisture Resistance	Atmospheric: AC 300V, 1 min. DC 100V, 1 min. 350°C, 3 sec. +65°C to -10°C, 90% RH to 98% RH, Rated Voltage, 10 cycles (240 hrs.)	±0.03% over 10,000 MΩ ±0.03% ±0.1%	±0.0025% over 10,000 MΩ ±0.01% ±0.05%
Life (Rated Load)	70°C, Rated Power, 1.5 hrs. – ON, 0.5 hr. – OFF, 1,000 hrs.	±0.1%	±0.01%
Storage Life	15°C to 35°C, 15% RH to 75% RH, No Load, 10,000 hrs.	±0.02%	±0.01%
High Temperature Exposure	155°C, No Load, 1,000 hrs.	±0.05%	±0.02%
Current Noise		-25 dB	-35 dB

Ultra Precision Thermosensitive Resistor

This ultra precision thermosensitive resistor is a new type of resistor produced by the application of Alpha foil resistor technology. It is made of material only a few μm thick and responds rapidly to temperature changes. The metal foil that is used has a resistivity that varies linearly with temperature change. Strict control of foil composition maintains uniform quality without fluctuation of temperature characteristics of resistance. This thermosensitive resistor is produced by the same fine photo-etching technology used in the metal foil precision resistors. The pattern is ideally designed for temperature detection, providing small size and rapid response.

Characteristics

- ❶ Since the resistance is provided by metal foil, the resistance is highly stable with little change over time
- ❷ Temperature characteristics of resistance are almost linear
- ❸ Response to temperature changes is rapid
- ❹ This thermosensitive resistor is small and low-priced
- ❺ Highly accurate with tolerance of resistance values ±0.5%
- ❻ Temperature characteristics can be freely adjusted (KLC type)

Main Applications

- Cold-junction reference for thermocouple
- Temperature-compensation in load cell
- Temperature-compensation device in semiconductor circuit
- Temperature-sensing device

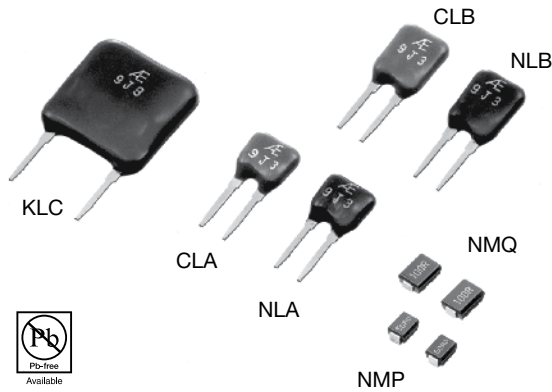

RoHS
COMPLIANT

COMPOSITION OF TYPE NUMBER

Example 1:

NLA 100R0 F

① ② ③

- ❶ Type
- ❷ Resistance Value*
- ❸ Tolerance

Example 2:

KLC 3000-500R0 F

① ② ③ ④

- ❶ Type
- ❷ TCR**
- ❸ Resistance Value*
- ❹ Tolerance

Example 3:

NMP 100R0 F L

① ② ③ ④

- ❶ Type
- ❷ Resistance Value*
- ❸ Tolerance
- ❹ Tape & Reel Package Required

*Resistance value, in ohm, is expressed by a series of five characters, four of which represent significant digits. R or K is a dual-purpose letter that designates both the value range (R for ohmic; K for kilo-ohm) and the location of decimal point.

**Specify a desired TCR, following the type, in four-digit coding. The example "3000" means 3,000 ppm/°C while "0500" means 500 ppm/°C.

CONFIGURATION (DIMENSIONS IN mm)

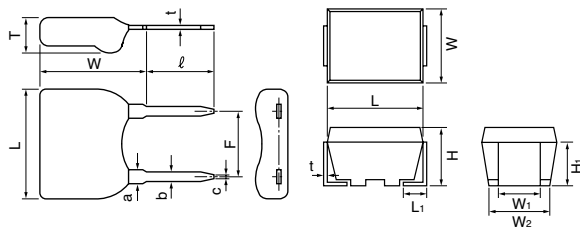

Type	NLA, CLA	NLB, CLB	KLC
L	5.6±0.5		12.4±0.5
W	6.2±0.5	8.2±0.5	13.3±0.5
T	2.2±0.5		3.3±0.5
F	2.54±0.25		7.62±0.25
ℓ	5.0±1.0		
t	0.3±0.05		
a	1.0±0.05		
b	0.65±0.05		
c	0.4±0.05		

Type	NMP	NMQ
L	3.2±0.2	4.5±0.2
W	2.5±0.2	3.2±0.2
T	2.0±0.2	
L1	0.6±0.2	0.8±0.2
W1	1.4±0.3	
W2	2.3±0.2	3.0±0.2
H1	1.5±0.3	
t	0.15±0.05	

TCR, RESISTANCE RANGE, TOLERANCE, RATED POWER

Type	TCR (ppm/°C)	Resistance Range (Ω)	Resistance Tolerance (%) at 0°C	Rated Power (W) at 70°C
NMP	+6,060±2% (0 to 25°C) +6,260±2% (0 to 50°C) +6,660±2% (0 to 100°C)	5 to 250	±0.5 (D) * ±1.0 (F) ±2.0 (G) ±5.0 (J)	0.1
NMQ	Rt=R ₀ (1+At+Bt ²) A:5.851E-03 B:7.382E-06	5 to 500		0.125
NLA	+6,060±1% (0 to 25°C) +6,260±1% (0 to 50°C) +6,660±1% (0 to 100°C)	5 to 500		0.125
NLB	Rt=R ₀ (1+At+Bt ²) A:5.851E-03 B:7.382E-06	5 to 1k		0.25
CLA	+4,250±1% (0 to 100°C)	5 to 100		0.125
CLB		5 to 200		0.25
KLC	See Fig.1 on next page			0.25

TAPE AND REEL PACKAGE (BASED ON EIA-481-1)

For details, refer to MP, MQ Series datasheet.

*Symbols parenthesized are for type number composition.

TCR SPREAD FROM NOMINAL AND DISTRIBUTION

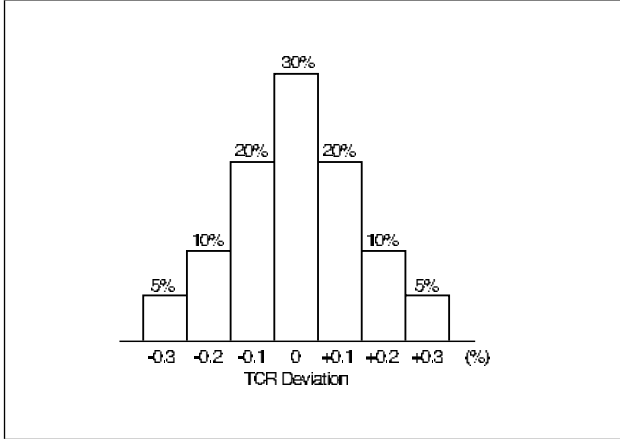

TEMPERATURE CHARACTERISTICS OF RESISTANCE

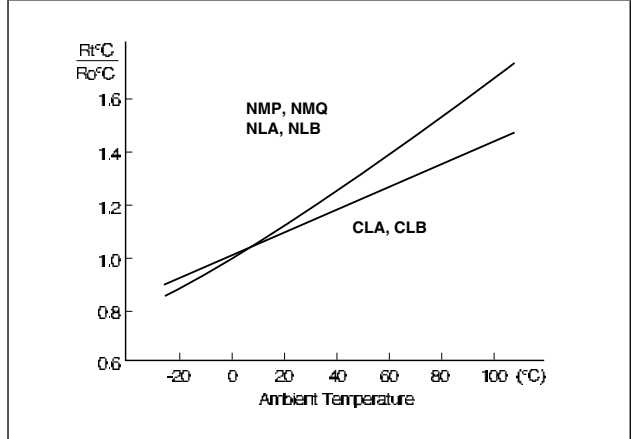
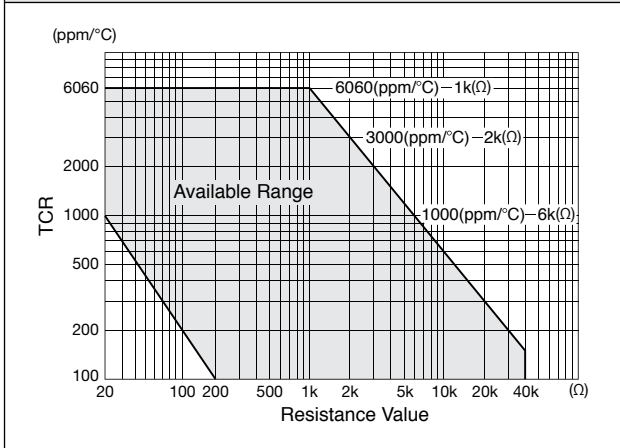
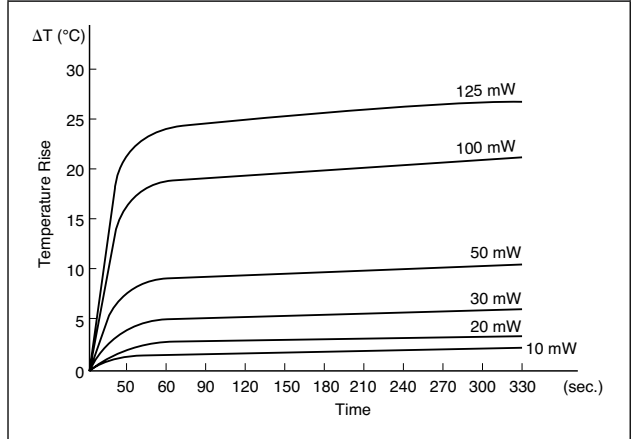

FIG. 1 TCR AND RESISTANCE AVAILABLE IN KLC TYPE



TEMPERATURE OF RESISTOR SURFACE



RESPONSE TIME TO TEMPERATURE CHANGE

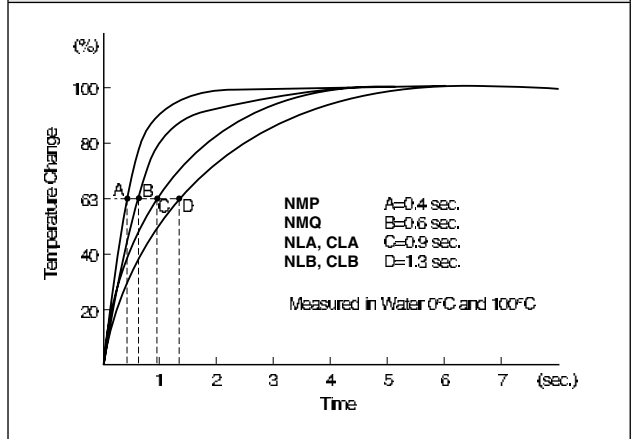

PERFORMANCE			
Parameters	Test Condition	ALPHA Specification	ALPHA Typical Test Data
Working Temperature Range Max. Rated Operating Temp. Maximum Working Voltage		-25°C to +125°C 70°C NMP: 50V; NMQ: 100V NLA, CLA: 250V; NLB, CLB, KLC: 300V	
Temperature Cycling Overload	-25°C/30 min., Room Temperature/5 min., +125°C/30 min., 5 cycles Rated Voltage x 2.5, 5 sec.	±0.2% ±0.2%	±0.03% ±0.03%
Solderability Resistance to Solvents	235°C, 2 sec. ● Isopropyl Alcohol ● Trichloroethylene	over 75% coverage no damage	
Low Temperature Storage Terminal Strength	-25°C, No Load, 2 hrs. 0.908 kg (2 pounds), 10 sec.	±0.2% ±0.2%	±0.03% ±0.03%
Dielectric Withstanding Voltage Insulation Resistance Resistance to Soldering Heat Moisture Resistance	Atmospheric: AC 300V, 1 min. DC 100V, 1 min. 350°C, 3 sec. +65°C to -10°C, 90% RH to 98% RH, Rated Voltage, 10 cycles (240 hrs.)	±0.2% over 10,000 MΩ ±0.2% ±0.5%	±0.03% over 10,000 MΩ ±0.01% ±0.02%
Shock Vibration	50G, 11 ms, Half-Sine Wave, X, Y, Z, each 3 shocks 20G, 10 Hz to 55 Hz to 10 Hz, 1 min., X, Y, Z, each 2 hrs.	±0.2% ±0.2%	±0.03% ±0.03%
Life (Rated Load)	70°C, Rated Power, 1.5 hr. – ON, 0.5 hr. – OFF, 1,000 hrs.	±0.5%	±0.03%
Life (Moisture Load)	40°C, 90% RH to 95% RH, Rated Power, 1.5 hr. – ON, 0.5 hr. – OFF, 1,000 hrs.	±0.5%	±0.03%
Storage Life	15°C to 35°C, 15% RH to 75% RH, No Load, 10,000 hrs.	±0.5%	±0.05%
High Temperature Exposure	125°C, No Load, 1,000 hrs.	±1.0 %	±0.1 %

APPLICATIONS OF THERMOSENSITIVE RESISTORS

Example: Cold-junction compensation for temperature measurement using thermocouple

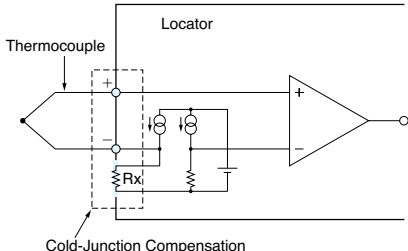

Cold-Junction Compensation

Example: Temperature-sensing circuit

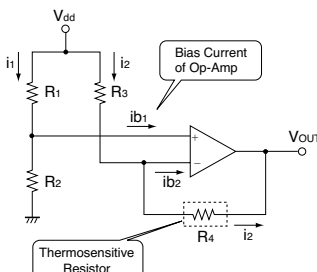

As shown in:

$$V_{OUT} = \left(\frac{R_2}{R_1+R_2} - \frac{R_1}{R_1+R_2} \times \frac{R_4}{R_3} \right) \times V_{dd}$$

Op-Amp output (V_{out}) becomes zero when R_1/R_2 and R_3/R_4 are balanced. So, output voltage ΔV_{out} is $\pm i_2 \times \Delta R_4$ when R_4 is changed to ΔR_4 from balanced point, $i_1=i_2$ and offset voltage is zero. The formula is as follows:

$$V_{OUT} = - \left(\frac{R_1}{R_1+R_2} \times \frac{1}{R_3} \right) \times \Delta R_4 \times V_{dd}$$

PRECAUTION IN USING NMP AND NMQ RESISTORS

1. Storage

Storage condition or environment may adversely affect solderability of the exterior terminals. Do not store in high temperature and humidity. The recommended storage environment is lower than 40°C, has less than 70% RH humidity and is free from harmful gases such as sulphur and chlorine.

2. Caution in Soldering

① Hand Soldering

Hand soldering is applicable as shown at right.

Recommended

- Temperature of Iron Tip: 240°C to 270°C
- Power of Iron: 20W or less
- Diameter of Tip: Dia. 3 mm max.

② Solder Reflow in Furnace

Recommended

- Peak Temperature: 250+0/-5°C
- Holding time: 10 sec. max.

③ Dipping in Solder (Wave or Still)

Recommended

- Temp. of Solder: 260°C max.
- Length of Dipping: 10 sec. max.
- To cool gradually at room temperature

④ Other

Corrosion-free flux, such as rosin, is recommended.

Do not apply pressure to the molded housing immediately after soldering.

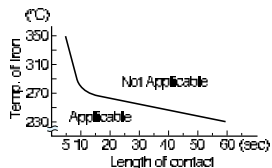

3. Cleaning

Use volatile cleaner such as methylalcohol or propylalcohol.

4. Circuit Board Design

The dimensions of solder land must be determined in conformity with the size of resistors and with the soldering method. They are also subject to the mounting machine and the material of the substrate. See example below.

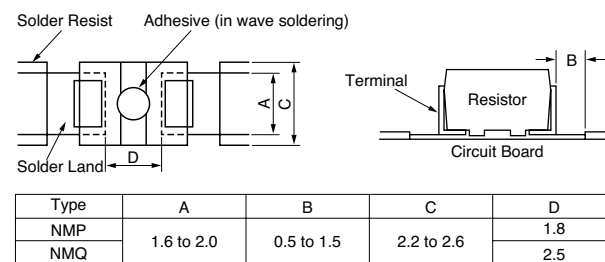

Dimensions in mm

When parts are mounted on a board in high density, solder can possibly attach to the resistors in an excessive amount to affect performance or reliability of the resistors. To prevent this effect, the use of solder resist is recommended to isolate solder lands.

Products for Ultra Precision Resistors and Temperature Sensors

SMT 1-2-3 NETWORK RESISTOR (FLIP-CHIP)

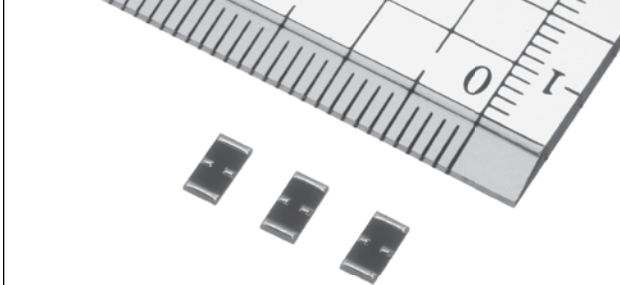

- 5.0 mm x 2.5 mm
- Flip-chip construction offers saving space
- Excellent cost performance

SMT NETWORK RESISTOR (HERMETIC PACKAGE)

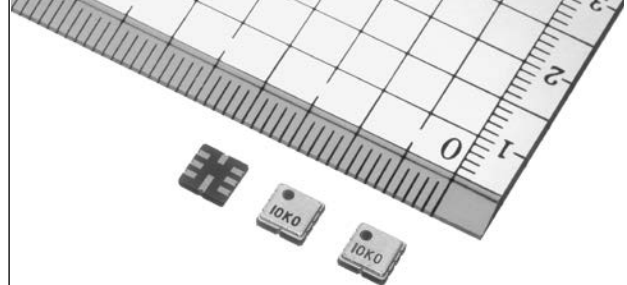

- 5 mm x 5 mm
- Excellent moisture resistance
- Excellent long-term stability
- Excellent TCR

ULTRA PRECISION HIGH POWER SHUNT RESISTOR

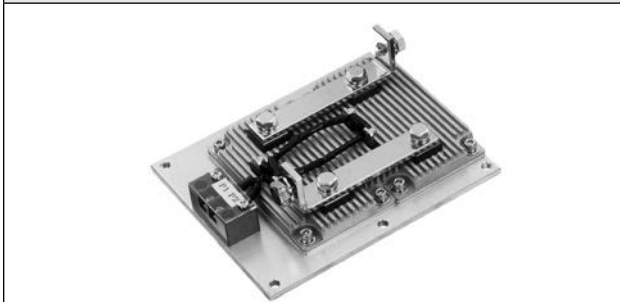

- Parallel connected PSB for handling high power current
- Available tight tolerance and lower resistance value than single PSB

AC COAXIAL SHUNT RESISTOR



- Coaxial construction for AC
- Current terminal designed for excellent heat dissipation

PT TEMPERATURE SENSORS



- Pt temperature sensor utilizing Pt Metal Foil® technology
- Available variety of packages and lead connections

MATCHED RESISTOR SETS

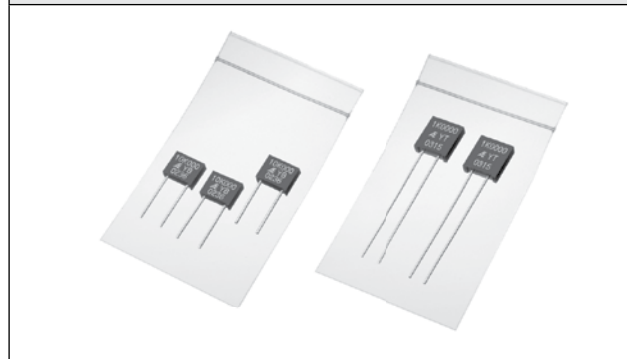

- 0.005% matching tolerance available
- 0.5 ppm/°C tracking TCR available

Product and Contact Information

PRODUCT LISTING

Bulk Metal® Foil Ultra Precision Resistors
Precision Thin Film Resistors
Thermosensitive Resistors
Standard Resistors

CONTACT US

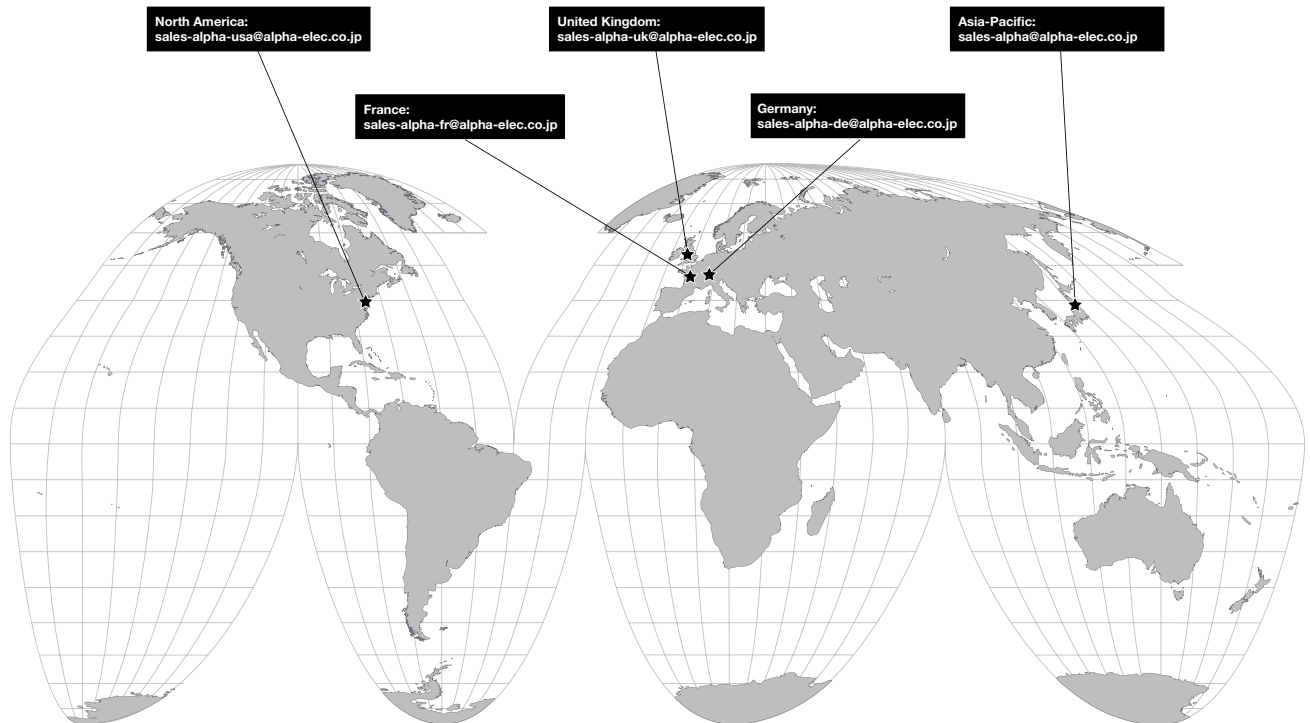
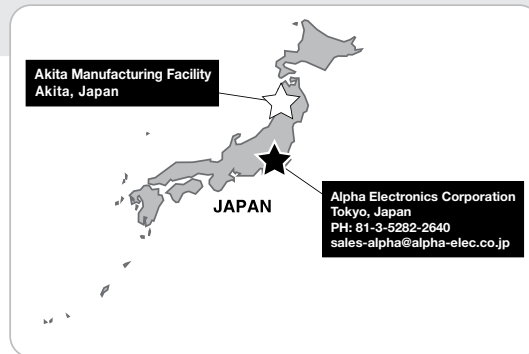

VPG Foil Resistors

Vishay Foil Resistors • Alpha Electronics • Powertron

VPG Foil Resistors stands for unparalleled precision, stability and reliability. Our resistor portfolio encompasses a wide variety of configurations and packages designed to surpass the requirements of even the most demanding applications.

Represented by the premier brands Vishay Foil Resistors, Alpha Electronics, and Powertron, our unique Bulk Metal® Foil technology outperforms all other resistor technologies. Continuously refined since its introduction in 1962, this ultra-precision technology is the solution of choice due to a distinct technical advantage over other options — the ability to deliver a completely customizable solution for any application.

To complement our extensive portfolio of high-performance foil resistors, we also offer decade boxes, standard resistors, exceptional precision thin film and power resistors including special construction configurations to meet the requirements of high temperature applications.

Portfolio Performance Highlights

- Extremely low TCR: 0.2 ppm/°C typical
- TCR tracking available to 0.1 ppm/°C
- Excellent load-life stability/ratio stability:
±0.002% max ΔR per MIL standard;
ultra long term stability: <1 ppm/year
- Very low resistance values from 0.0005 Ω
- Any 6-digit value in the resistance range available at no additional cost with any tolerance (to 0.001%)
- High power up to 2500 W
- Shelf life: 2 ppm over more than six years
- Rapid thermal stabilization: <1 s
- Thermal EMF: 0.05 $\mu V/^\circ C$
- Electrostatic discharge (ESD): to at least 25 kV
- Non-inductive: <0.08 μH
- Certification to NIST standards
- Special design to meet high temperature application requirements up to +240°C ambient temperature



About Our Brands



Vishay Foil Resistors Bulk Metal® Foil resistors provide extremely low temperature coefficient of resistance (TCR) and exceptional long-term stability through temperature extremes. The Vishay Foil Resistors portfolio includes discrete resistors and resistor networks in surface-mount and through-hole (leaded) configurations, precision trimming potentiometers, and discrete chips for use in hybrid circuits, with customized chip resistor networks and arrays available. We continue to develop, manufacture and market new types of Bulk Metal Foil resistors, including military-established-reliability components (EEE-INST-002, DLA, CECC, ESA, ER, QPL, etc).



Alpha Electronics has been supplying ultra-precision Bulk Metal® Foil resistors to engineers from Japan with "Stability, Accuracy, and Reliability" since 1978. The resistance stability of Alpha foil resistor technology against changes in temperature and over time makes the devices excellent metrological standard resistors as well. Without needing the oil baths required by conventional standard resistors, they are a popular choice by national standard institutes and local calibration laboratories for primary and secondary standards. Alpha's standard resistors are available in a variety of models to fit a wide range of applications. Our ultra-precision thermosensitive resistor features a resistivity that varies linearly with temperature change, and is ideally designed for temperature detection and compensation applications with small size and rapid response.



Powertron is dedicated to the development, manufacturing and marketing of high-precision Bulk Metal® Foil, current sense and thick film resistors for use in diverse applications. Made in Germany, with local customer service and technical support, we offer a full complement of resistors for accurate, precise and high-power circuits (up to 2500 W), with full customization capabilities to support virtually any package type. We focus on delivering solutions with the best combination of power ratings, TCR and resistance ranges. As a result, our products are used throughout the world in high-precision medical, aerospace, military and industrial applications.

Contact us at foil@vpgsensors.com



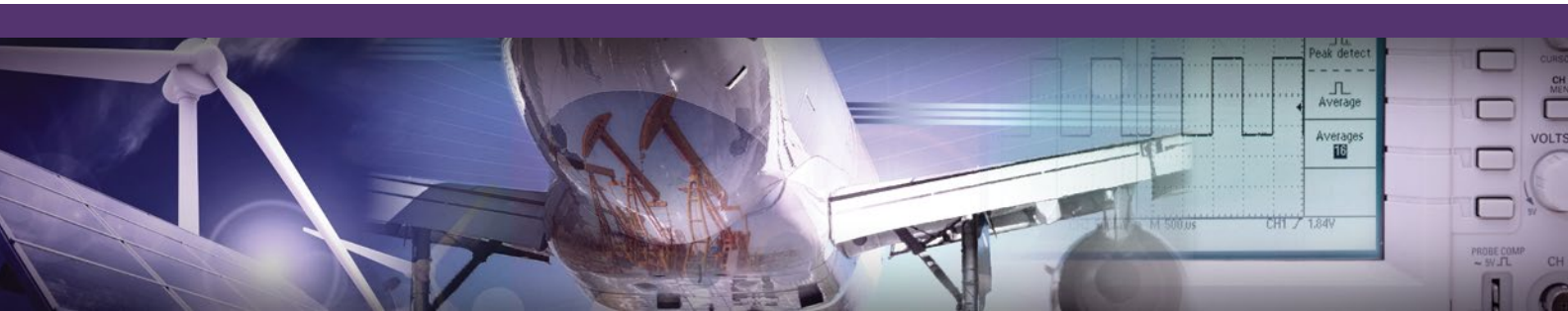

Contact

sales-alpha@alpha-elec.co.jp

alpha-elec.co.jp